



LTS-7000 3730 SERIES

0.43" SINGLE DIGIT NUMERIC DISPLAYS

FEATURES

- 0.43 INCH (10.9mm) DIGIT HEIGHT.
- CONTINUOUS UNIFORM SEGMENTS.
- CHOICE OF SIX BRIGHT COLORS-RED/BRIGHT RED GREEN/YELLOW/ORANGE/HIGH EFFICIENCY
- LOW POWER REQUIREMENT.
- EXCELLENT CHARACTERS APPEARANCE.
- HIGH BRIGHTNESS.
- WIDE VIEWING ANGLE.
- SOLID STATE RELIABILITY.
- CATEGORIZED FOR LUMINOUS INTENSITY.
- I.C. COMPATIBLE.
- EASY MOUNTING ON P.C. BOARDS.

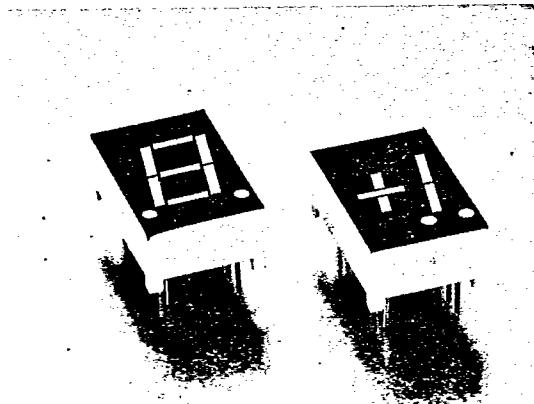

DESCRIPTION

The LTS-7000/3730 series are 0.43 inch (10.9mm) height single digit displays.

The red series devices utilize LED chips which are made from GaAsP on a GaAs substrate. The bright red and green series devices utilize LED chips which are made from GaP on a transparent GaP substrate. The yellow, orange and high efficiency red series devices utilize LED chips which are made from GaAsP on a transparent GaP substrate. Red and bright red displays have black face and red segment color. Green, yellow and orange displays have gray face and white segment color. High efficiency red displays have red face and red segment color.

SEVEN-SEGMENT
LED DISPLAYS

DEVICES

PART NO. LTS--						DESCRIPTION	PACKAGE DIMENSION	INTERNAL CIRCUIT DIAGRAM
RED	BRIGHT RED	GREEN	YELLOW	ORANGE	HI-EFF RED			
7751R	7751P	7671GN	7661YN	3731E	7651HR	Common Anode, Rt. & Lt. Hand Decimal	A	A
7760R	7760P	7673GN	7663YN	3733E	7653HR	Common Cathode, Rt. Hand Decimal	A	B
7756R	7756P	7676GN	7666YN	3736E	7656HR	Universal, ± Overflow	B	C

6-88
563

PACKAGE DIMENSIONS

A. LTS-7751/7661/7671/3731/7651
7760/7663/7673/3733/7653

B. LTS-7756/7666/7676/3736/7656

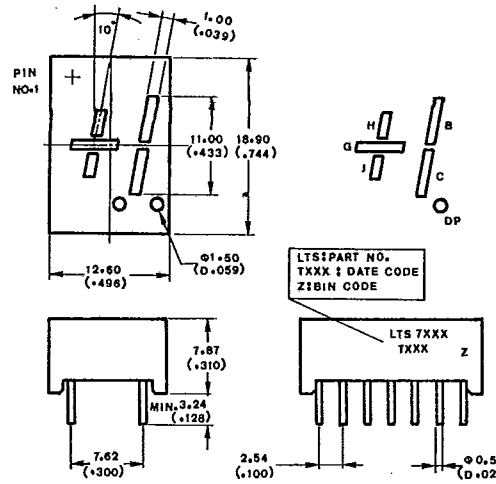
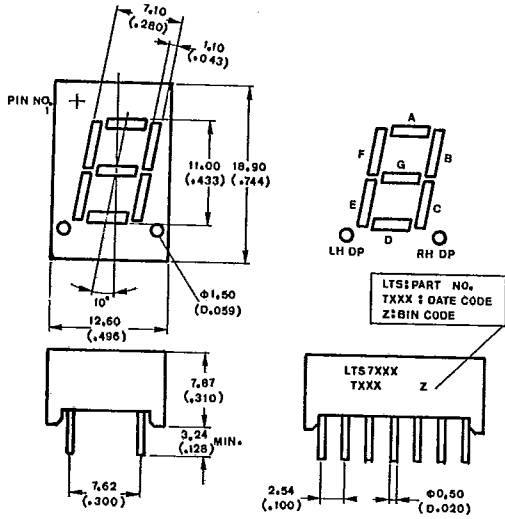

NOTE: All dimensions are in $\frac{\text{millimeters}}{\text{(inches)}}$ tolerance is $\frac{0.25\text{mm}}{(0.010'')}$ unless otherwise noted.

PIN CONNECTION

PIN NO.	CONNECTION		
	A. LTS-7751R/7751P/7671GN 7661YN/3731E/7651HR	B. LTS-7760R/7760P/7673GN 7663YN/3733E/7653HR	C. LTS-7756R/7756P/7676GN 7666YN/3736E/7656HR
1	Cathode A	Anode A	Cathode H
2	Cathode F	Anode F	Anode H
3	Common Anode*	Common Cathode*	No Pin
4	No Pin	No Pin	Cathode G
5	No Pin	No Pin	Cathode J
6	Cathode L.H.D.P.	No Connection	Anode J
7	Cathode E	Anode E	Anode G
8	Cathode D	Anode D	Anode D.P.
9	Cathode R.H.D.P.	Anode R.H.D.P.	Cathode D.P.
10	Cathode C	Anode C	Cathode C
11	Cathode G	Anode G	Cathode B
12	No Pin	No Pin	No Pin
13	Cathode B	Anode B	Anode B
14	Common Anode*	Common Cathode*	Anode C

6-89
564

NOTE: Pin 3 & 14 are internally connected.

INTERNATIONAL CIRCUIT DIAGRAM

A. LTS-7551/7661
3731/7651

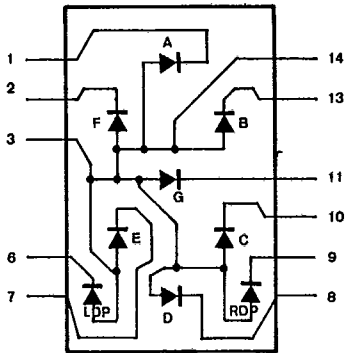

B. LTS-7760/7663/7673
3733/7653

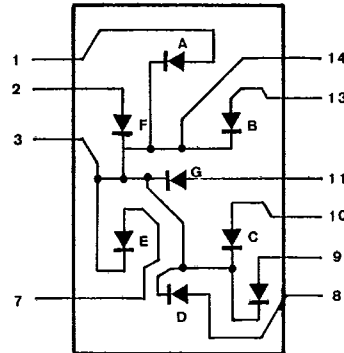

C. LTS-7756/7666/7676
3736/7656

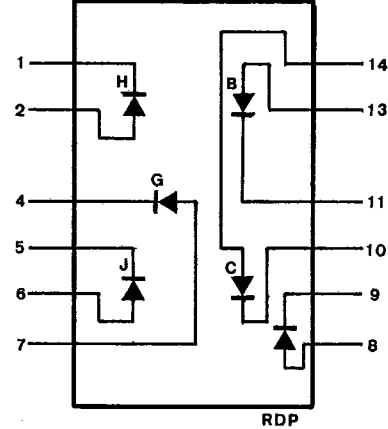

ABSOLUTE MAXIMUM RATINGS AT Ta = 25°C

PARAMETER	RED	BRIGHT RED	GREEN	YELLOW	ORANGE	HI.-EFF. RED	UNIT
Power Dissipation Per Segment	55	40	75	60	75	75	mW
Peak Forward Current Per Segment (1/10 Duty Cycle, 0.1ms Pulse Width)	160	60	100	80	100	100	mA
Continuous Forward Current Per Segment	25	15	25	20	25	25	mA
Derating Linear From 25°C Per Segment	0.3	0.18	0.3	0.24	0.3	0.3	mA/°C
Reverse Voltage Per Segment	5	5	5	5	5	5	V
Operating Temperature Range	-25°C to +85°C						
Storage Temperature Range	-25°C to +85°C						
Solder Temperature 1/16 inch Below Seating Plane for 3 Seconds at 260°C							

SEVEN-SEGMENT LED DISPLAYS

ELECTRICAL/OPTICAL CHARACTERISTICS AT $T_A = 25^\circ\text{C}$
LTS-7751R/7760R/7756R

PARAMETER	SYMBOL	MIN.	TYP.	MAX.	UNIT	TEST CONDITION
Average Luminous Intensity	I_v	200	500		μcd	$I_F = 10\text{ mA}$
Peak Emission Wavelength	λ_p		655		nm	$I_F = 20\text{ mA}$
Spectral Line Half-Width	$\Delta\lambda$		24		nm	$I_F = 20\text{ mA}$
Forward Voltage, any Segment or D.P.	V_F		1.7	2.0	V	$I_F = 20\text{ mA}$
Reverse Current, any Segment or D.P.	I_R			100	μA	$V_R = 5\text{V}$
Luminous Intensity Matching Ratio	$I_v\text{-m}$			2:1		$I_F = 20\text{ mA}$

Note: The BIN brightness classification see page 6-160, LTS-7751R categorize B-1 and LTS-7760R/7756R categorize B.

TYPICAL ELECTRICAL/OPTICAL CHARACTERISTIC CURVES
 (25°C Ambient Temperature Unless Otherwise Noted)

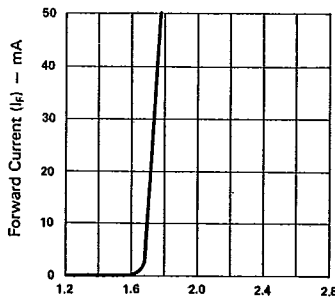

Forward Voltage (V_F) — Volts
 Fig. 1 FORWARD CURRENT Vs. FORWARD VOLTAGE.

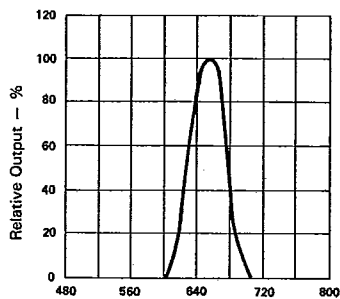

Wavelength (λ) — nm.
 Fig. 2 SPECTRAL RESPONSE.

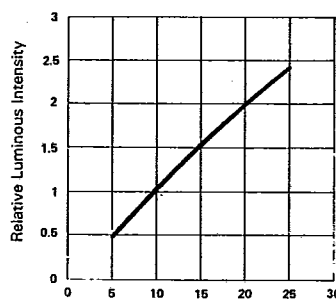

Forward Current (I_F) — mA
 Fig. 3 RELATIVE LUMINOUS INTENSITY Vs. FORWARD CURRENT (PER SEGMENT).

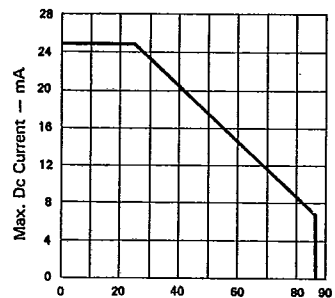

Ambient Temperature (T_A) — °C
 Fig. 4 MAX. ALLOWABLE DC CURRENT PER SEG. Vs AMBIENT TEMPERATURE.

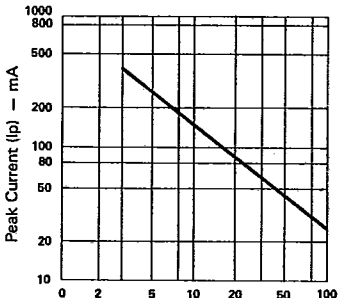

Duty Cycle %
 Fig. 5 MAX. PEAK CURRENT Vs. DUTY CYCLE.% (REFRESH RATE — $F = 1\text{ KHz}$)

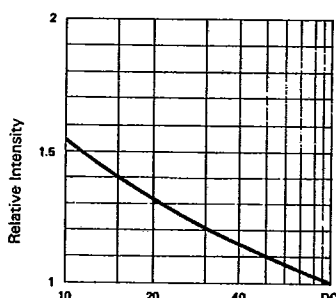

Duty Cycle %
 Fig. 6 LUMINOUS INTENSITY Vs. DUTY CYCLE.% (AVERAGE $I_F = 10\text{mA}$ PER SEG.)

**ELECTRICAL/OPTICAL CHARACTERISTICS AT $T_A = 25^\circ\text{C}$
LTS-7751P/7760P/7756P**

PARAMETER	SYMBOL	MIN.	TYP.	MAX.	UNIT	TEST CONDITION
Average Luminous Intensity	I_v	300	750		μcd	$I_F = 10\text{ mA}$
Peak Emission Wavelength	λ_p		697		nm	$I_F = 20\text{ mA}$
Spectral Line Half-Width	$\Delta\lambda$		90		nm	$I_F = 20\text{ mA}$
Forward Voltage, any Segment or D.P.	V_F		2.1	2.8	V	$I_F = 20\text{ mA}$
Reverse Current, any Segment or D.P.	I_R			100	μA	$V_R = 5\text{ V}$
Luminous Intensity Matching Ratio	$I_v\text{-m}$			2:1		$I_F = 20\text{ mA}$

Note: The BIN brightness classification see page 6-160, LTS-7751D categorize B-1 and LTS7760P/7756P categorize B.

TYPICAL ELECTRICAL/OPTICAL CHARACTERISTIC CURVES
(25°C Ambient Temperature Unless Otherwise Noted)

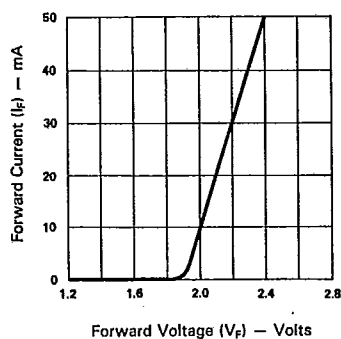

Fig. 1 FORWARD CURRENT VS. FORWARD VOLTAGE.

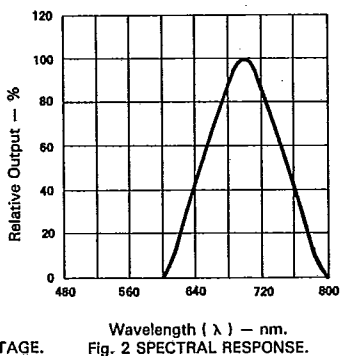

Fig. 2 SPECTRAL RESPONSE.

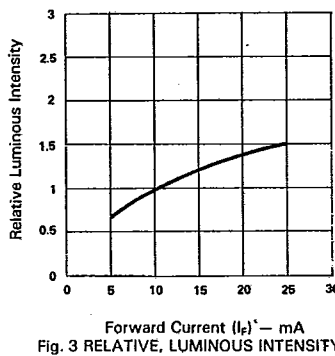

Fig. 3 RELATIVE, LUMINOUS INTENSITY VS. FORWARD CURRENT (PER SEGMENT).

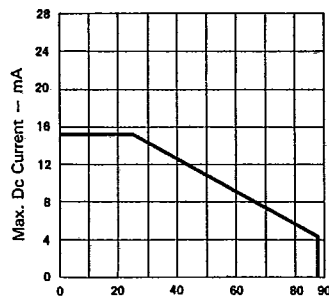

Fig. 4 MAX. ALLOWABLE DC CURRENT PER SEG. VS AMBIENT TEMPERATURE.

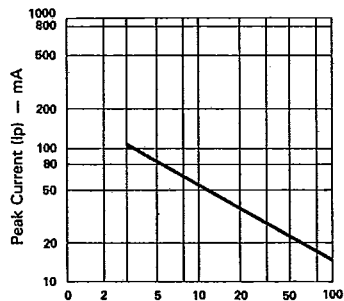

Fig. 5 MAX. PEAK CURRENT VS. DUTY CYCLE.% (REFRESH RATE - F = 1 KHz)

SEVEN-SEGMENT
LED DISPLAYS

ELECTRICAL/OPTICAL CHARACTERISTICS AT TA = 25°C
LTS-7671GN/7673GN/7676GN

PARAMETER	SYMBOL	MIN.	TYP.	MAX.	UNIT	TEST CONDITION
Average Luminous Intensity	Iv	800	2000		μcd	IF = 10 mA
Peak Emission Wavelength	λp		565		nm	IF = 20 mA
Spectral Line Half-Width	Δλ		30		nm	IF = 20 mA
Forward Voltage, any Segment or D.P.	VF		2.1	2.8	V	IF = 20 mA
Reverse Current, any Segment or D.P.	IR			100	μA	VR = 5V
Luminous Intensity Matching Ratio	Iv-m			2:1		IF = 20 mA DD

Note: The BIN brightness classification see page 6-160, category B

TYPICAL ELECTRICAL/OPTICAL CHARACTERISTIC CURVES

(25°C Ambient Temperature Unless Otherwise Noted)

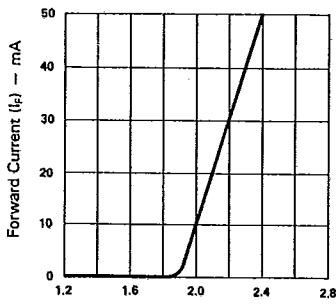

Fig. 1 FORWARD CURRENT Vs. FORWARD VOLTAGE.

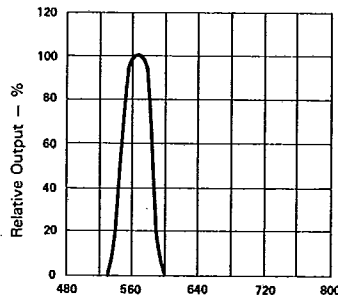

Fig. 2 SPECTRAL RESPONSE.

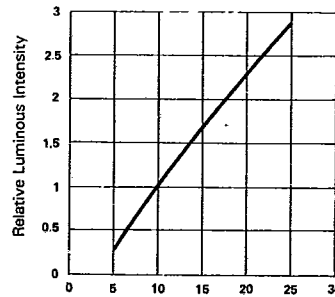

Fig. 3 RELATIVE LUMINOUS INTENSITY Vs. FORWARD CURRENT (PER SEGMENT).

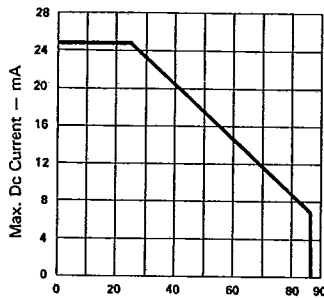

Fig. 4 MAX. ALLOWABLE DC CURRENT PER SEG. Vs AMBIENT TEMPERATURE.

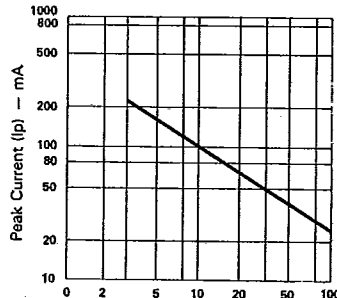

Fig. 5 MAX. PEAK CURRENT Vs. DUTY CYCLE.% (REFRESH RATE - F = 1 KHz)

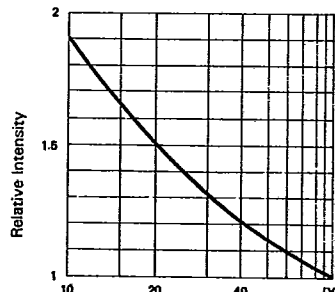

Fig. 6 LUMINOUS INTENSITY Vs. DUTY CYCLE% (AVERAGE If = 10mA PER SEG.)

ELECTRICAL/OPTICAL CHARACTERISTICS AT Ta = 25°C
LTS-7761YN/7763YN/7666YN

PARAMETER	SYMBOL	MIN.	TYP.	MAX.	UNIT	TEST CONDITION
Average Luminous Intensity	I_v	700	2000		μcd	$I_F = 10 \text{ mA}$
Peak Emission Wavelength	λ_p		586		nm	$I_F = 20 \text{ mA}$
Spectral Line Half-Width	$\Delta\lambda$		35		nm	$I_F = 20 \text{ mA}$
Forward Voltage, any Segment or D.P.	V_F		2.1	2.8	V	$I_F = 20 \text{ mA}$
Reverse Current, any Segment or D.P.	I_R			100	μA	$V_R = 5\text{V}$
Luminous Intensity Matching Ratio	$I_v\text{-m}$			2:1		$I_F = 20 \text{ mA}$

Note: The BIN brightness classification see page 6-160, category B

TYPICAL ELECTRICAL/OPTICAL CHARACTERISTIC CURVES

(25°C Ambient Temperature Unless Otherwise Noted)

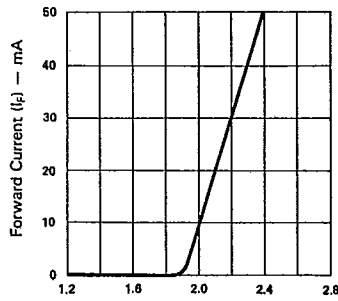

Fig. 1 FORWARD CURRENT Vs. FORWARD VOLTAGE.

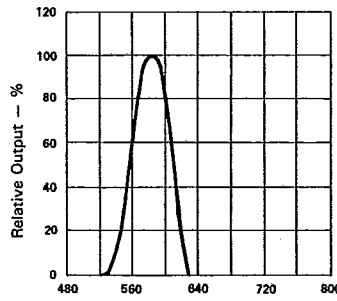

Fig. 2 SPECTRAL RESPONSE.

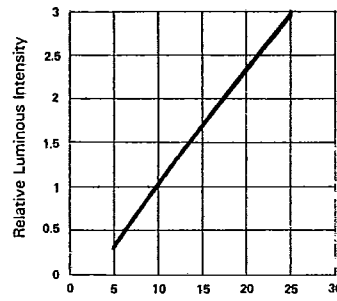

Fig. 3 RELATIVE LUMINOUS INTENSITY Vs. FORWARD CURRENT (PER SEGMENT).

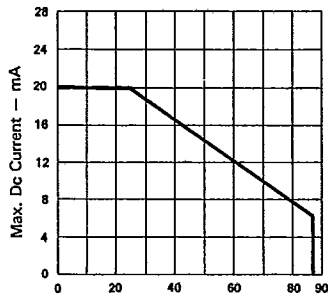

Fig. 4 MAX. ALLOWABLE DC CURRENT PER SEG. Vs AMBIENT TEMPERATURE.

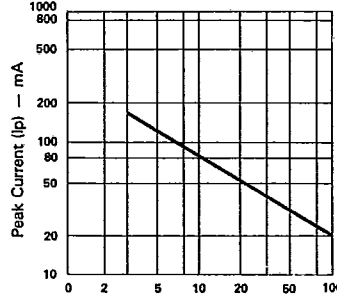

Fig. 5 MAX. PEAK CURRENT Vs. DUTY CYCLE.% (REFRESH RATE - F = 1 KHz)

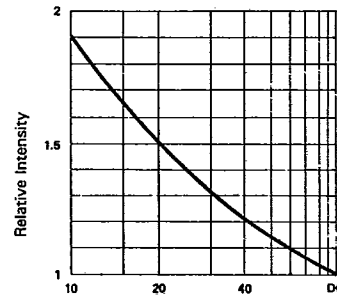

Fig. 6 LUMINOUS INTENSITY Vs. DUTY CYCLE% (AVERAGE $I_F = 10\text{mA}$ PER SEG.)

SEVEN-SEGMENT LED DISPLAYS

ELECTRICAL/OPTICAL CHARACTERISTICS AT TA = 25°C
LTS-3731E/3733E/3736E

PARAMETER	SYMBOL	MIN.	TYP.	MAX.	UNIT	TEST CONDITION
Average Luminous Intensity	I_v	800	2000		μcd	$I_F = 10 \text{ mA}$
Peak Emission Wavelength	λ_p		630		nm	$I_F = 20 \text{ mA}$
Spectral Line Half-Width	$\Delta\lambda$		40		nm	$I_F = 20 \text{ mA}$
Forward Voltage, any Segment or D.P.	V_F		2.1	2.8	V	$I_F = 20 \text{ mA}$
Reverse Current, any Segment or D.P.	I_R			100	μA	$V_R = 5 \text{ V}$
Luminous Intensity Matching Ratio	$I_v\text{-m}$			2:1		$I_F = 20 \text{ mA}$

Note: The BIN brightness classification see page 6-160, category B

TYPICAL ELECTRICAL/OPTICAL CHARACTERISTIC CURVES

(25°C Ambient Temperature Unless Otherwise Noted)

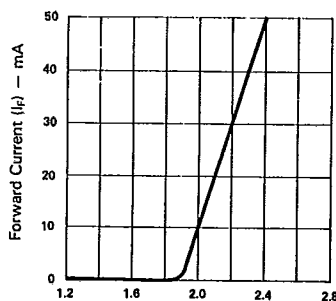

Forward Voltage (V_F) — Volts
 Fig. 1 FORWARD CURRENT Vs. FORWARD VOLTAGE.

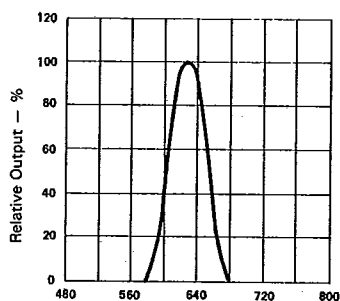

Wavelength (λ) — nm.
 Fig. 2 SPECTRAL RESPONSE.

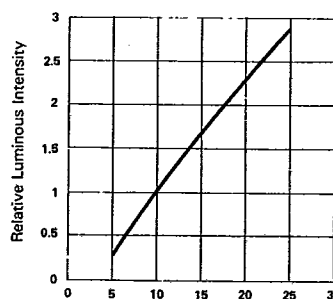

Forward Current (I_F) — mA
 Fig. 3 RELATIVE LUMINOUS INTENSITY Vs. FORWARD CURRENT (PER SEGMENT).

LZ

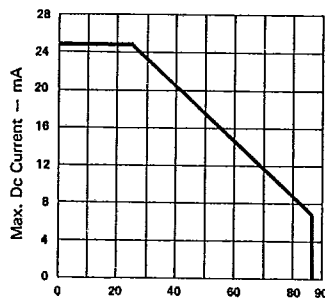

Ambient Temperature (T_a) — °C
 Fig. 4 MAX. ALLOWABLE DC CURRENT PER SEG. Vs AMBIENT TEMPERATURE.

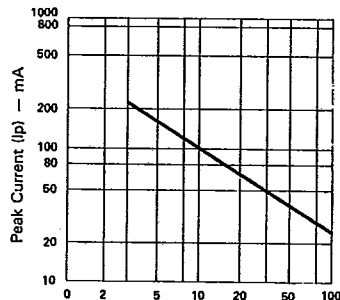

Duty Cycle %
 Fig. 5 MAX. PEAK CURRENT Vs. DUTY CYCLE.% (REFRESH RATE — F = 1 KHz)

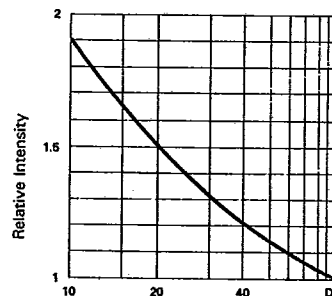

Duty Cycle %
 Fig. 6 LUMINOUS INTENSITY Vs. DUTY CYCLE.% (AVERAGE $I_F = 10 \text{ mA}$ PER SEG.)

ELECTRICAL/OPTICAL CHARACTERISTICS AT TA = 25°C
LTS-7651HR/7653HR/7656HR

PARAMETER	SYMBOL	MIN.	TYP.	MAX.	UNIT	TEST CONDITION
Average Luminous Intensity	Iv	800	2000		μcd	IF = 10 mA
Peak Emission Wavelength	λp		635		nm	IF = 20 mA
Spectral Line Half-Width	Δλ		40		nm	IF = 20 mA
Forward Voltage, any Segment or D.P.	VF		2.1	2.8	V	IF = 20 mA
Reverse Current, any Segment or D.P.	IR			100	μA	VR = 5V
Luminous Intensity Matching Ratio	Iv-m			2:1		IF = 20 mA

Note: The BIN brightness classification see page 6-160, category B-1

TYPICAL ELECTRICAL/OPTICAL CHARACTERISTIC CURVES
 (25°C Ambient Temperature Unless Otherwise Noted)

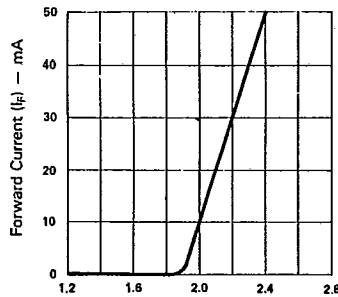

Fig. 1 FORWARD CURRENT Vs. FORWARD VOLTAGE.

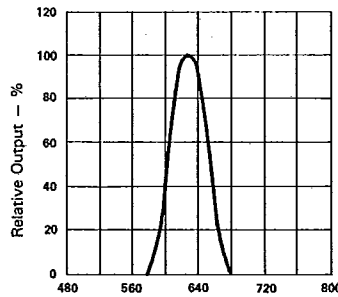

Fig. 2 SPECTRAL RESPONSE.

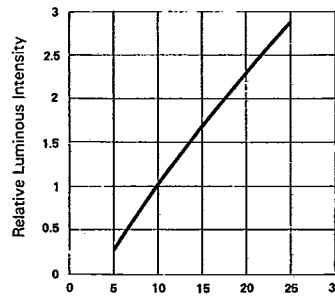

Fig. 3 RELATIVE LUMINOUS INTENSITY Vs. FORWARD CURRENT (PER SEGMENT).

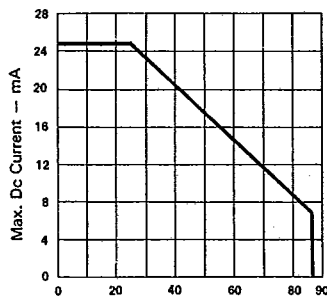

Fig. 4 MAX. ALLOWABLE DC CURRENT PER SEG. Vs AMBIENT TEMPERATURE.

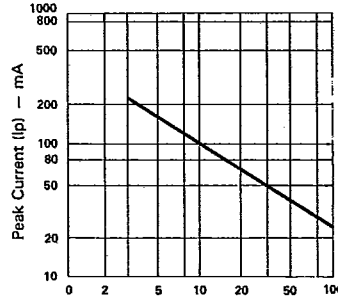

Fig. 5 MAX. PEAK CURRENT Vs. DUTY CYCLE.% (REFRESH RATE - F = 1 KHz)

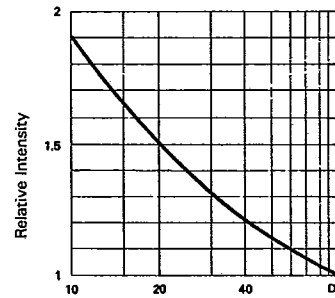

Fig. 6 LUMINOUS INTENSITY Vs. DUTY CYCLE% (AVERAGE If = 10mA PER SEG.)

SEVEN-SEGMENT
LED DISPLAYS