

LINEAR INTEGRATED CIRCUITS

TBA 810CB TBA 810ACB

PRELIMINARY DATA

FULLY-PROTECTED 7-W AUDIO POWER AMPLIFIER FOR CITIZENS' BAND RADIO

- HIGH OUTPUT POWER (7W AT 16V/4Ω; 14.4V/2Ω)
- HIGH OUTPUT CURRENT (3A REPETITIVE)
- HIGH SUPPLY VOLTAGE REJECTION RATIO (40 dB min)
- LOW NOISE
- LOAD DUMP PROTECTION UP TO 40V
- LOAD SHORT CIRCUIT PROTECTION UP TO $V_s = 15V$
- POLARITY INVERSION PROTECTION
- THERMAL PROTECTION

The TBA 810CB is a monolithic integrated circuit in a 12-lead quad in-line plastic package, expressly designed for use as a power audio amplifier in CB radios.

The TBA 810 ACB has the same electrical characteristics as the TBA 810CB but its cooling tabs are flat and pierced so that an external heatsink can be easily attached.

ABSOLUTE MAXIMUM RATINGS

$V_{s(\text{peak})}$	Peak supply voltage (50 ms)	40	V
V_s	DC supply voltage	28	V
V_s	Operating supply voltage	20	V
I_o	Output peak current (non repetitive)	4	A
I_o	Output peak current (repetitive)	3	A
P_{tot}	Power dissipation at $T_{\text{amb}} \leq 80^\circ\text{C}$ (for TBA 810CB)	1	W
	$T_{\text{tab}} \leq 100^\circ\text{C}$ (for TBA 810ACB)	5	W
T_{stg}, T_j	Storage and junction temperature	-40 to 150	$^\circ\text{C}$

MECHANICAL DATA

Dimensions in mm

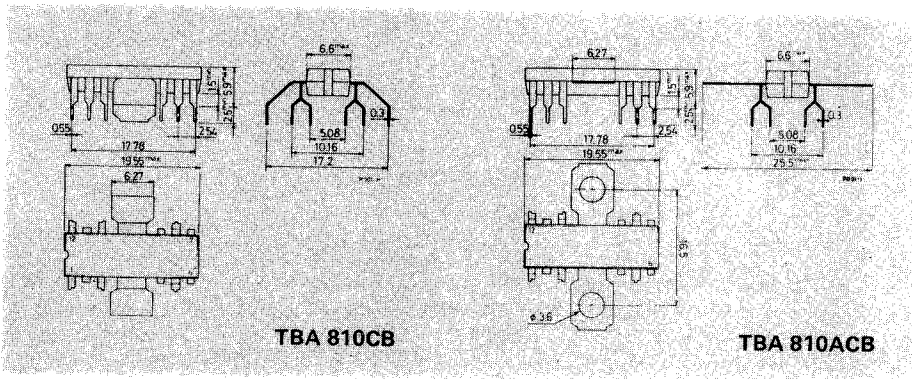

TBA 810 CB TBA 810 ACB

CONNECTION AND SCHEMATIC DIAGRAMS

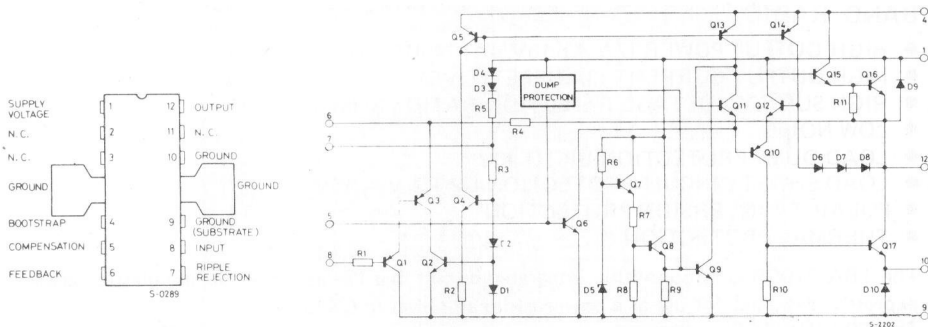

TEST AND APPLICATION CIRCUIT

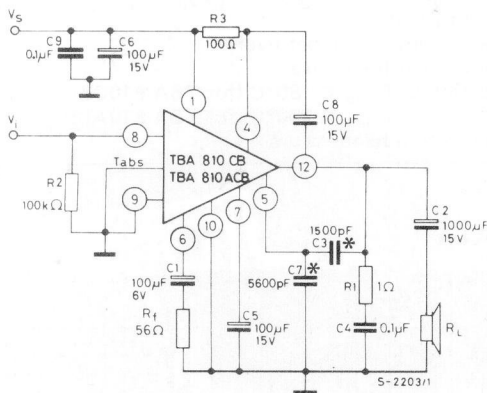

THERMAL DATA

			TBA 810CB	TBA 810ACB
$R_{th\ j-tab}$	Thermal resistance junction-tab	max	12°C/W	10°C/W
$R_{th\ j-amb}$	Thermal resistance junction-ambient	max	70°C/W	80°C/W

* Obtained with tabs soldered to printed circuit with minimized copper area

TBA 810CB TBA 810ACB

ELECTRICAL CHARACTERISTICS (Refer to the test circuit; $V_s = 14.4V$, $T_{amb} = 25^\circ C$ unless otherwise specified)

Parameter		Test conditions		Min.	Typ.	Max.	Unit
V_s	Supply voltage (pin 1)			4		20	V
V_o	Quiescent output voltage (pin 12)			6.4	7.2	8	V
I_d	Quiescent drain current				12	20	mA
I_b	Bias current (pin 8)				0.4		μA
P_o	Output power	$d = 10\%$ $R_L = 4\Omega$ $R_L = 2\Omega$	$f = 1 \text{ kHz}$	5.5 5.5	6 7		W W
$V_{i(rms)}$	Input saturation voltage			220			mV
V_i	Input sensitivity	$f = 1 \text{ kHz}$ $P_o = 6W$ $R_f = 56\Omega$ $R_f = 22\Omega$ $P_o = 7W$ $R_f = 56\Omega$ $R_f = 22\Omega$	$R_L = 4\Omega$ $R_L = 2\Omega$		75 30		mV mV
R_i	Input resistance (pin 8)				5		$M\Omega$
B	Frequency response (-3 dB)	$R_L = 4\Omega/2\Omega$ $C_3 = 820 \text{ pF}$ $C_3 = 1500 \text{ pF}$				40 to 20 000 40 to 10 000	Hz Hz
d	Distortion	$P_o = 50 \text{ mW to } 2.5W$ $R_L = 4\Omega/2\Omega$ $f = 1 \text{ kHz}$			0.3		%
G_v	Voltage gain (open loop)	$R_L = 4\Omega$	$f = 1 \text{ kHz}$		80		dB
G_v	Voltage gain (closed loop)	$R_L = 4\Omega/2\Omega$	$f = 1 \text{ kHz}$	34	37	40	dB
e_N	Input noise voltage	$V_s = 16V$			2		μV
i_N	Input noise current	B (-3 dB) = 40 to 15 000 Hz			80		pA
η	Efficiency	$P_o = 6W$ $f = 1 \text{ kHz}$	$R_L = 4\Omega$		75		%
SVR	Supply voltage rejection ratio	$R_L = 4\Omega$ $f_{ripple} = 100 \text{ Hz}$	$V_{ripple} = 1V_{rms}$	40	48		dB

TBA 810CB TBA 810ACB

Fig. 1 - Output power vs. supply voltage

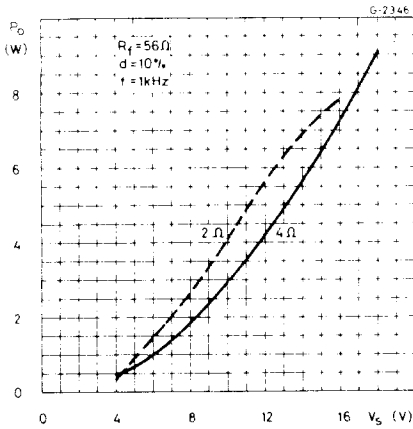

Fig. 2 - Maximum power dissipation vs. supply voltage (sine wave operation)

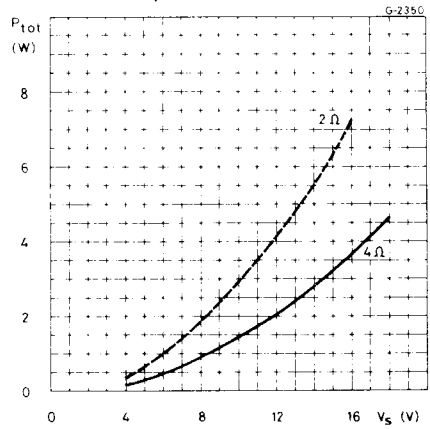

Fig. 3 - Distortion vs. frequency ($R_L = 4\ \Omega$)

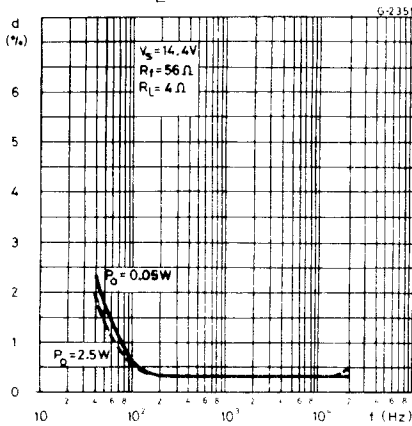
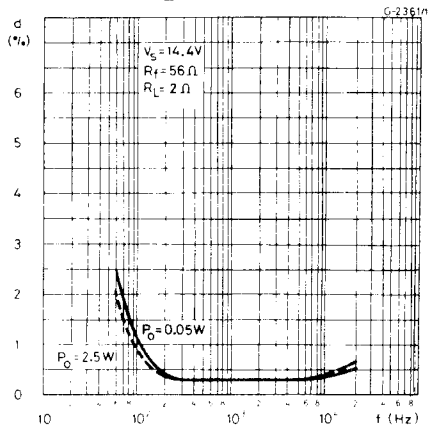

Fig. 4 - Distortion vs. frequency ($R_L = 2\ \Omega$)



TBA 810 CB TBA 810 ACB

Fig. 5 - Distortion vs. output power

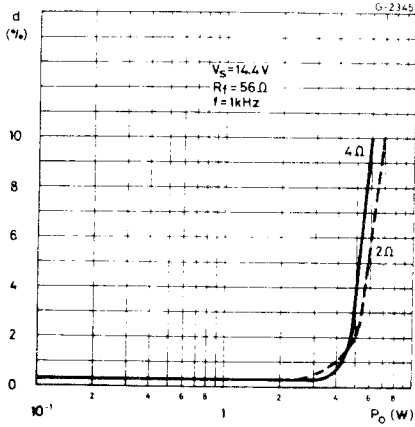

Fig. 6 - Typical value of C3 vs. feedback resistance for various values of B

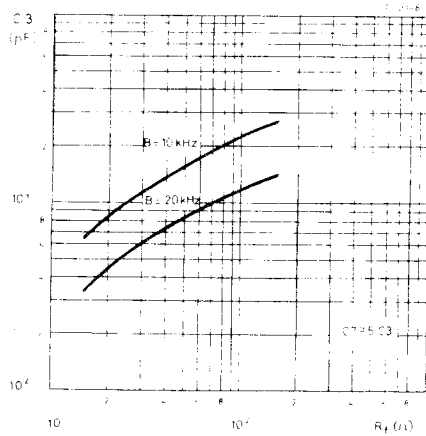

Fig. 7 - Relative voltage gain (closed loop) and input voltage vs. feedback resistance

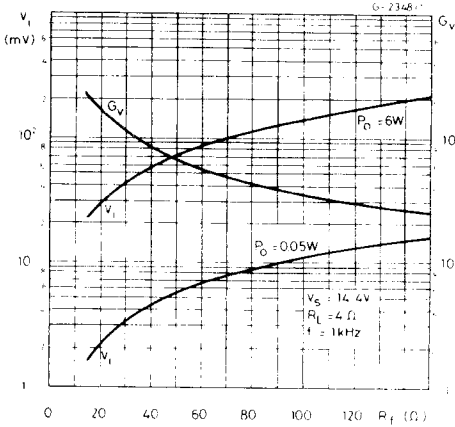
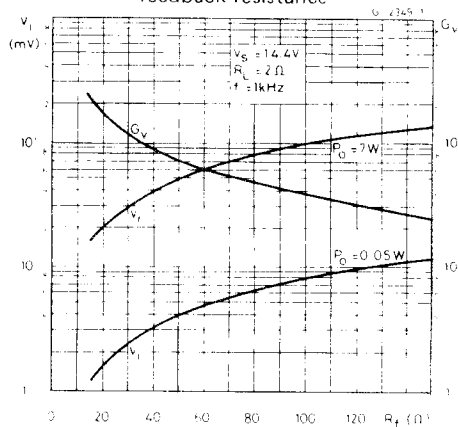

Fig. 8 - Relative voltage gain (closed loop) and input voltage vs. feedback resistance



TBA 810 CB TBA 810 ACB

Fig. 9 - Total power dissipation and efficiency vs. output power

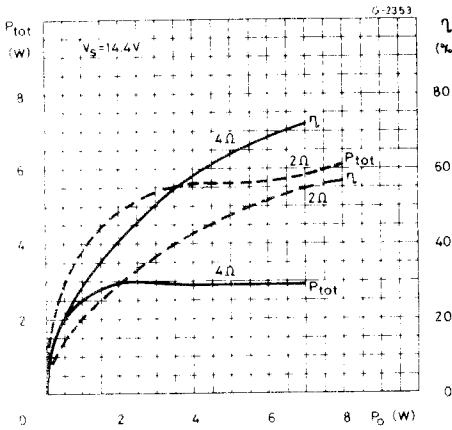

Fig. 10 - Quiescent output voltage (pin 12) vs. supply voltage

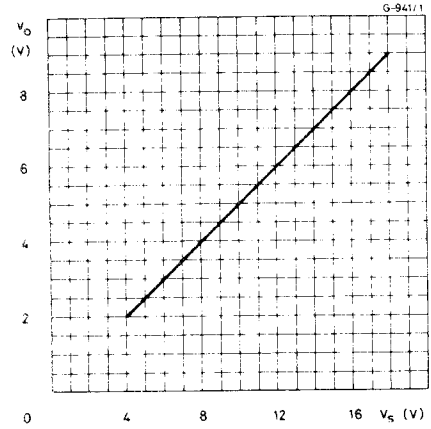

Fig. 11 - Quiescent drain current vs. supply voltage

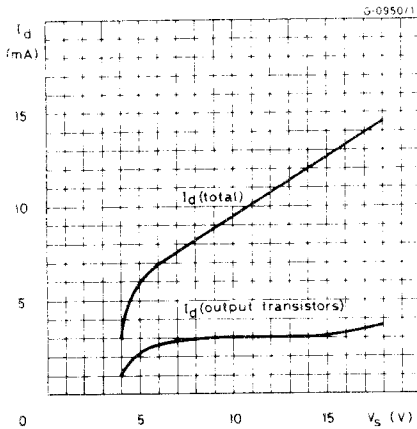
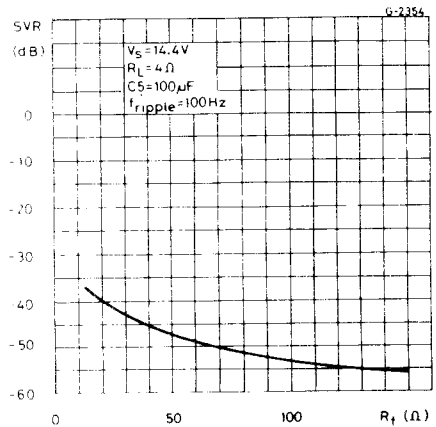

Fig. 12 - Supply voltage rejection ratio vs. feedback resistance



BUILT-IN PROTECTION SYSTEMS

Load dump protection

The load dump case occurs in a car when the engine is running and the battery is disconnected: voltage spikes on the power line are supplied by the alternator since there is no clamping effect due to battery capacitance.

The TBA 810CB was designed to withstand a pulse train on pin 1, of the type shown in Fig. 13. Providing an LC filter is included, as shown in Fig. 14, a much higher pulse train amplitude (up to $100 V_{peak}$) is allowed on the supply line with no damage to the device.

Fig. 13

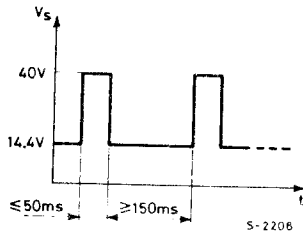
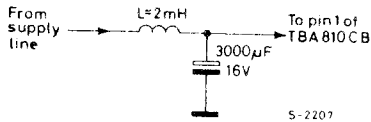

Fig. 14



Short-circuit protection

The TBA 810CB can withstand a permanent short circuit across the load for a supply voltage up to 15V.

Polarity inversion protection

High current (up to 5A) can be handled by the device with no damage for a longer period than the blow-out time of a quick 1A fuse (normally connected in series with the supply). This feature is added to avoid destruction if, during fitting to the car, a mistake on the connection of the supply is made.

Open ground protection

When the radio is in the ON condition and the ground is accidentally opened, a standard audio amplifier will be damaged. On the TBA 810CB, protection diodes are included to avoid any damage.

Inductive load protection

A protection diode is provided between pin 12 and pin 1 (see the internal schematic diagram) to allow use of the TBA 810CB with inductive loads.

In particular, the TBA 810CB can drive the coupling transformer for audio modulation in CB transmitters.

DC voltage protection

The maximum operating DC voltage on the TBA 810CB is 20V.

However the device can withstand a DC voltage up to 28V with no damage. This could occur during winter if two batteries were series connected to crank the engine.

TBA 810CB TBA 810ACB

Thermal protection

A thermal limiting circuit is internally provided on TBA 810CB to prevent chip temperature exceeding 150°C. This protection offers the following advantages:

1. An overload on the output (even if permanent), or an above-limit ambient temperature can be withstood.
2. The heatsink can be designed with smaller safety margins compared with that of a conventional power audio amplifier.

The TBA 810CB will remain undamaged in the event of excessive junction temperature: all that happens is that P_o (and therefore P_{tot}) are reduced (Fig. 15).

Fig. 15 - Output power and drain current vs. package temperature

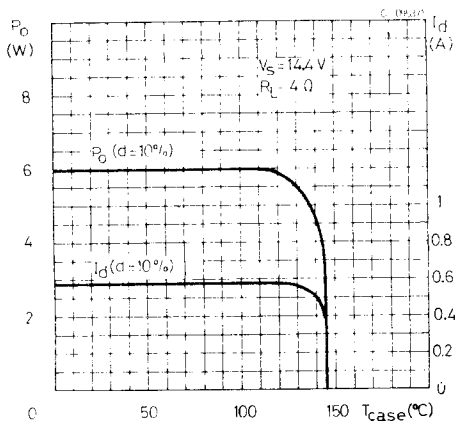

MOUNTING INSTRUCTIONS

The thermal power dissipated in the circuit may be removed by connecting the tabs to an external heatsink (Fig. 16) or by soldering them to an area of copper on the printed circuit board (Fig. 17). During soldering, tab temperature must not exceed 260°C and the soldering time must not be longer than 12 seconds.

Fig. 16 - TBA 810 ACB mounting example

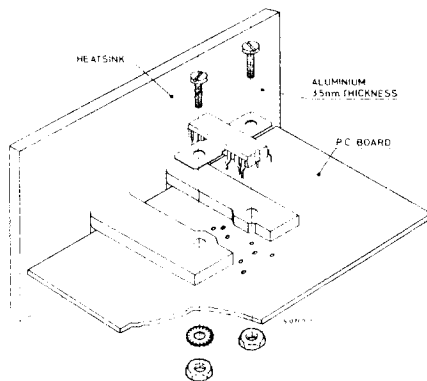
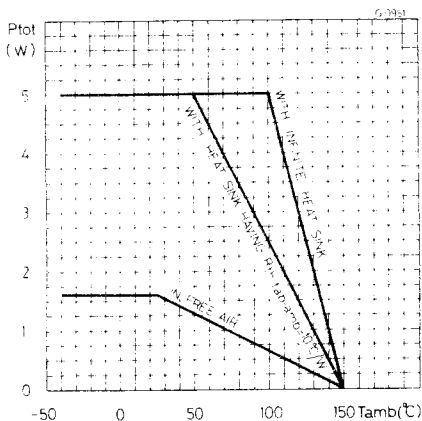
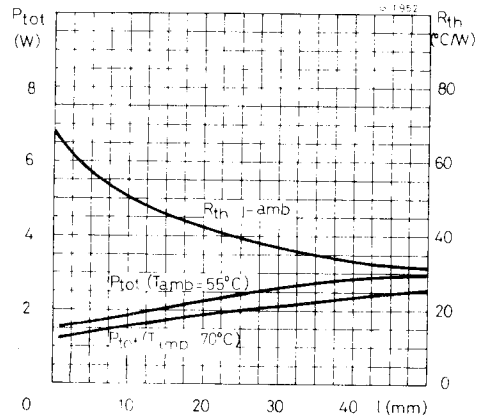
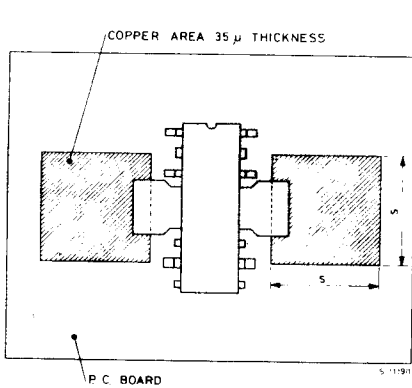

Fig. 17 - TBA 810CB mounting example



RELIABILITY

The reliability of the TBA 810CB is very high thanks to the Fin-Dip package and assembly process.

A CB radio is switched ON and OFF many thousands of times during the lifetime of the car. This causes thermal fatigue of the device and if suitable package and assembly processes were not used, failure of the die or wire bonding would be probable. Thanks to the particular process adopted for the TBA 810CB, the device can easily withstand the following stresses:

- thermal fatigue: more than 10^4 cycles with $\Delta T_{case} = 100^\circ\text{C}$
- thermal cycling: more than 10^3 cycles between -55°C and $+125^\circ\text{C}$
- thermal shocks: more than 10^3 cycles between -55°C and $+125^\circ\text{C}$
- relative humidity of 85% at 85°C is resisted for more than 10^3 hours.

TBA 810 CB TBA 810 ACB

Fig. 18 - P.C. board and component layout for the test and application circuit (1:1 scale)

