

VQ3001J/3001P

N-/P-Ch. Enhancement-Mode MOSFET Transistor Arrays

Product Summary

	$V_{(BR)DSS}$ Min (V)	$r_{DS(on)}$ Max (Ω)	$V_{GS(th)}$ (V)	I_D (A)
N-Channel	30	1 @ $V_{GS} = 12$ V	0.8 to 2.5	0.85
P-Channel	-30	2 @ $V_{GS} = -12$ V	-2 to -4.5	-0.6

Features

- Low On-Resistance: 0.8/1.6 Ω
- Low Threshold: 1.5/-3.1 V
- Low Input Capacitance: 38/60 pF
- Fast Switching Speed: 9/16 ns
- Low Input and Output Leakage

Benefits

- Low Offset Voltage
- Low-Voltage Operation
- Easily Driven Without Buffer
- High-Speed Circuits
- Low Error Voltage

Applications

- Direct Logic-Level Interface: TTL/CMOS
- Drivers: Relays, Solenoids, Lamps, Hammers, Displays, Memories, Transistors, etc.
- Battery Operated Systems
- Solid-State Relays

Plastic: VQ3001J
Sidebrazed: VQ3001P

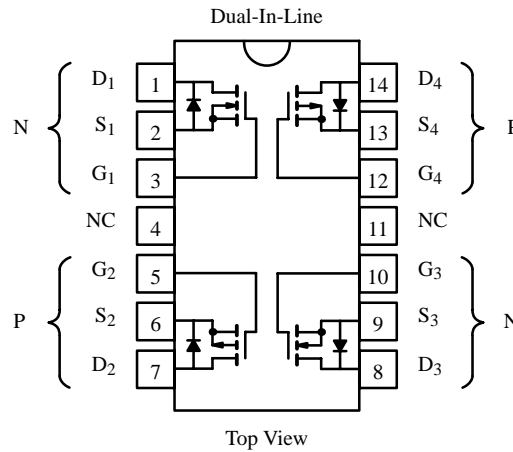

Absolute Maximum Ratings ($T_A = 25^\circ\text{C}$ Unless Otherwise Noted)

Parameter	Symbol	Single		Total Quad	Unit	
		N-Channel	P-Channel			
Drain-Source Voltage	V_{DS}	30	30		V	
Gate-Source Voltage	V_{GS}	± 20	± 20			
		± 20	± 20			
Continuous Drain Current ($T_J = 150^\circ\text{C}$)	I_D	$T_A = 25^\circ\text{C}$	0.85	-0.6	A	
		$T_A = 100^\circ\text{C}$	0.52	-0.37		
Pulsed Drain Current ^a	I_{DM}	3	-2			
Power Dissipation	P_D	$T_A = 25^\circ\text{C}$	1.3	1.3	2	W
		$T_A = 100^\circ\text{C}$	0.52	0.52	0.8	
Maximum Junction-to-Ambient	R_{thJA}	96.2	96.2	62.5	$^\circ\text{C}/\text{W}$	
Operating Junction and Storage Temperature Range	T_J, T_{stg}	-55 to 150		-55 to 150	$^\circ\text{C}$	

Notes

a. Pulse width limited by maximum junction temperature.

Updates to this data sheet may be obtained via facsimile by calling Siliconix FaxBack, 1-408-970-5600. Please request FaxBack document #70221.

VQ3001J/3001P

Specifications^a

Parameter	Symbol	Test Condition	Typ ^b	Limits				Unit
				N-Channel		P-Channel		
				Min	Max	Min	Max	
Static								
Drain-Source Breakdown Voltage	$V_{(BR)DSS}$	$V_{GS} = 0 \text{ V}, I_D = 10 \mu\text{A}$	55	30				V
		$V_{GS} = 0 \text{ V}, I_D = -10 \mu\text{A}$	-55			-30		
Gate-Source Threshold Voltage	$V_{GS(th)}$	$V_{DS} = V_{GS}, I_D = 1 \text{ mA}$	1.5	0.8	2.5			
		$V_{DS} = V_{GS}, I_D = -1 \text{ mA}$	-3.1			-2	-4.5	
Gate-Body Leakage	I_{GSS}	$V_{DS} = 0 \text{ V}, V_{GS} = \pm 20 \text{ V}$			± 100		± 100	nA
		$V_{DS} = 0 \text{ V}, V_{GS} = \pm 20 \text{ V}, T_J = 125^\circ\text{C}$			± 500		± 500	
Zero-Gate Voltage Drain Current	I_{DSS}	$V_{DS} = 24 \text{ V}, V_{GS} = 0 \text{ V}$			10			μA
		$V_{DS} = -24 \text{ V}, V_{GS} = 0 \text{ V}$					-10	
		$V_{DS} = 24 \text{ V}, V_{GS} = 0 \text{ V}, T_J = 125^\circ\text{C}$			500			
		$V_{DS} = -24 \text{ V}, V_{GS} = 0 \text{ V}, T_J = 125^\circ\text{C}$					-500	
On-State Drain Current ^c	$I_{D(on)}$	$V_{DS} = 10 \text{ V}, V_{GS} = 12 \text{ V}$	3	2				A
		$V_{DS} = -10 \text{ V}, V_{GS} = -12 \text{ V}$	-2			-1.5		
Drain-Source On-State Resistance ^c	$r_{DS(on)}$	$V_{GS} = 5 \text{ V}, I_D = 0.2 \text{ A}$	1.2		1.75			Ω
		$V_{GS} = 12 \text{ V}, I_D = 1 \text{ A}$	0.81		1.0			
		$V_{GS} = -12 \text{ V}, I_D = -1 \text{ A}$	1.6				2.0	
		$V_{GS} = 12 \text{ V}, I_D = 1 \text{ A}, T_J = 125^\circ\text{C}$	1.65		2.0			
		$V_{GS} = -12 \text{ V}, I_D = -1 \text{ A}, T_J = 125^\circ\text{C}$	2.7				4.0	
Forward Transconductance ^c	g_{fs}	$V_{DS} = 10 \text{ V}, I_D = 0.5 \text{ A}$	500	250				mS
		$V_{DS} = -10 \text{ V}, I_D = -0.5 \text{ A}$	390			200		
Dynamic								
Input Capacitance	C_{iss}	N-Channel $V_{DS} = 15 \text{ V}, V_{GS} = 0 \text{ V}, f = 1 \text{ MHz}$ P-Channel $V_{DS} = -15 \text{ V}, V_{GS} = 0 \text{ V}, f = 1 \text{ MHz}$	38		110			pF
Output Capacitance	C_{oss}		60				150	
Reverse Transfer Capacitance	C_{rss}		33		110			
			45				100	
Turn-On Time	t_{ON}		N-Channel $V_{DD} = 15 \text{ V}, R_L = 23 \Omega$ $I_D \cong 0.6 \text{ A}, V_{GEN} = 10 \text{ V}, R_G = 25 \Omega$ P-Channel $V_{DD} = -15 \text{ V}, R_L = 23 \Omega$ $I_D \cong -0.6 \text{ A}, V_{GEN} = -10 \text{ V}, R_G = 25 \Omega$	8		35		
		15					60	
Turn-Off Time	t_{OFF}	9			30			
		19					30	
		14			30			
		16				30		

Notes

- $T_A = 25^\circ\text{C}$ unless otherwise noted.
- For DESIGN AID ONLY, not subject to production testing.
- Pulse test: $PW \leq 300 \mu\text{s}$ duty cycle $\leq 2\%$.

VNDQ03/VPEA03

Typical Characteristics (25°C Unless Noted)

N-Channel

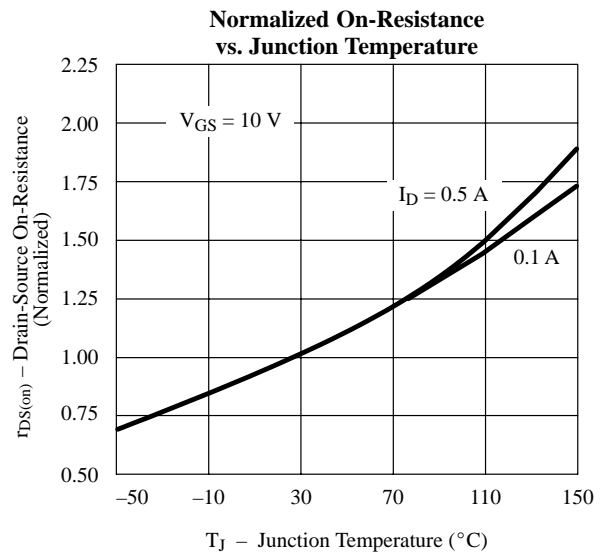
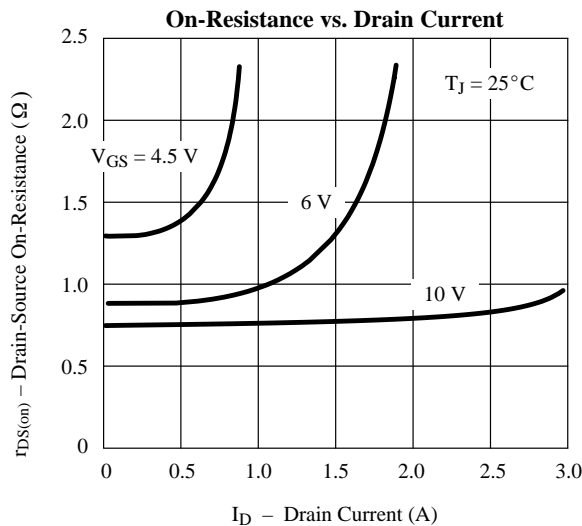
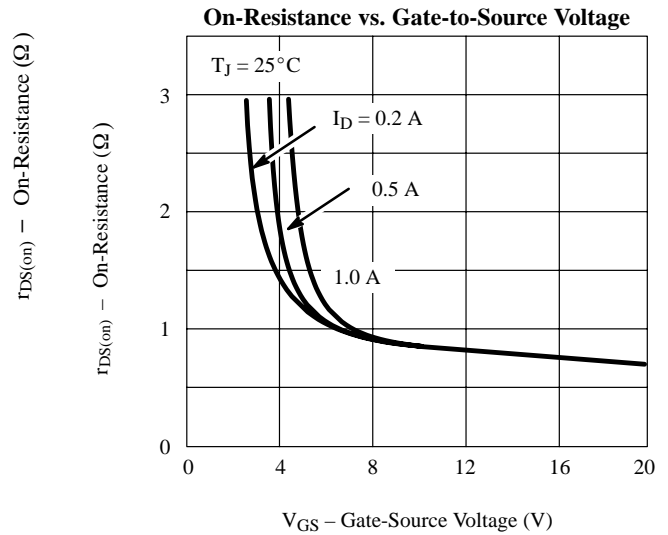
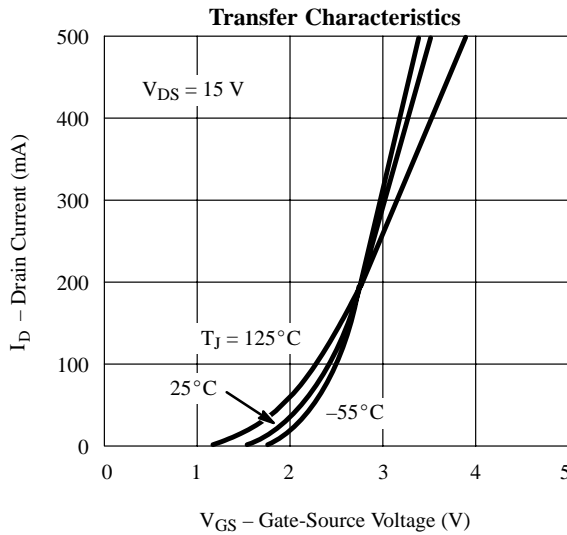
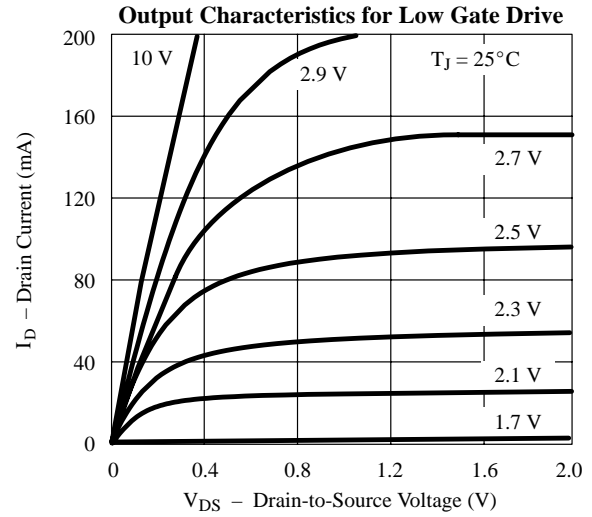
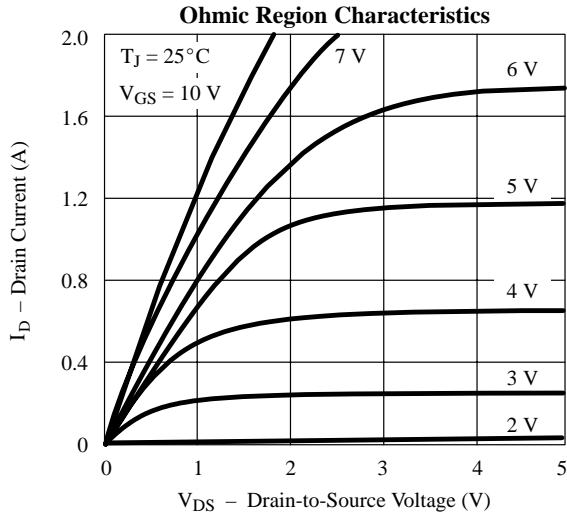

VQ3001J/3001P

Typical Characteristics (25°C Unless Noted)

N-Channel

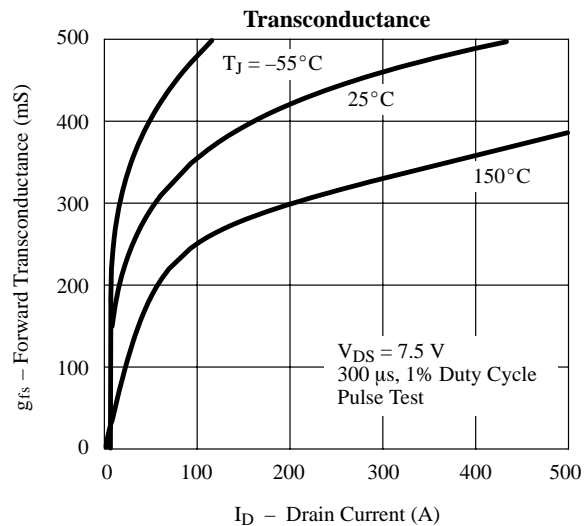
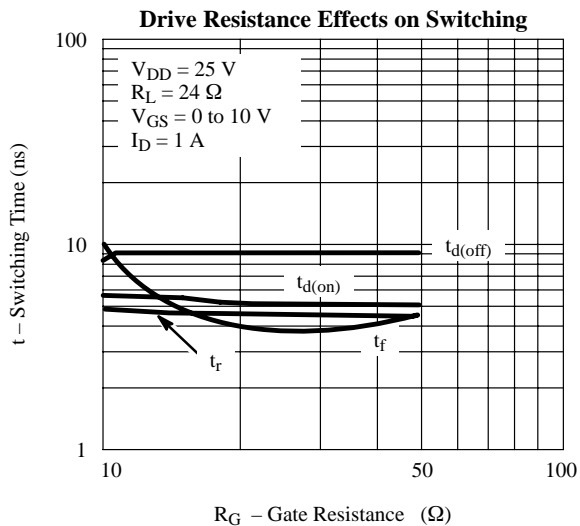
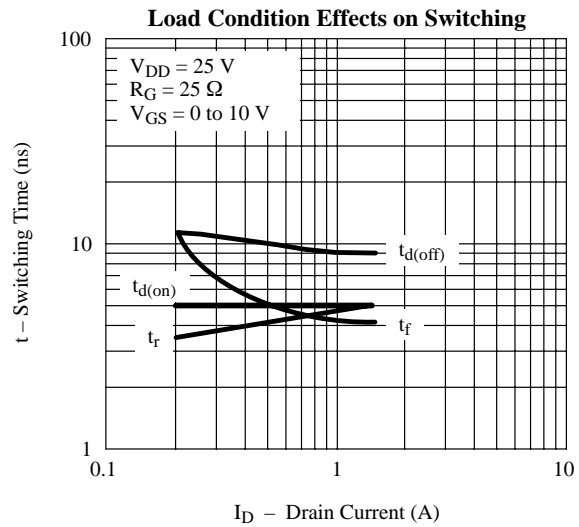
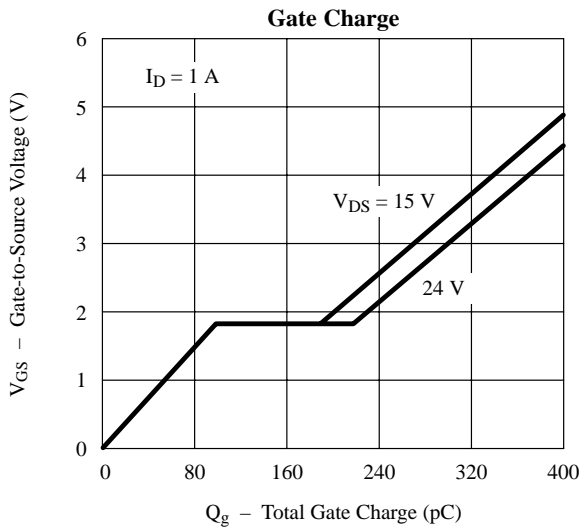
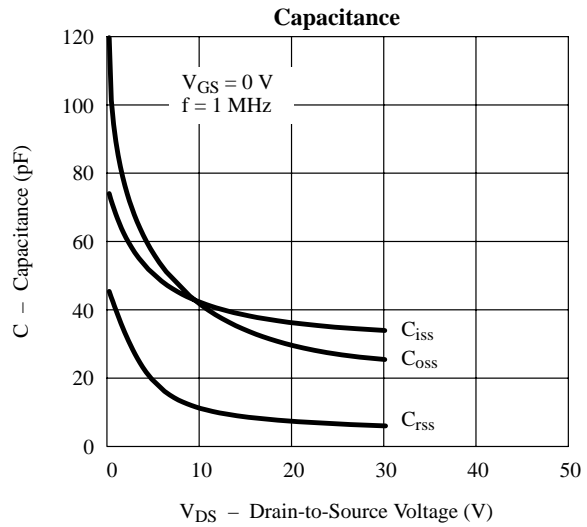
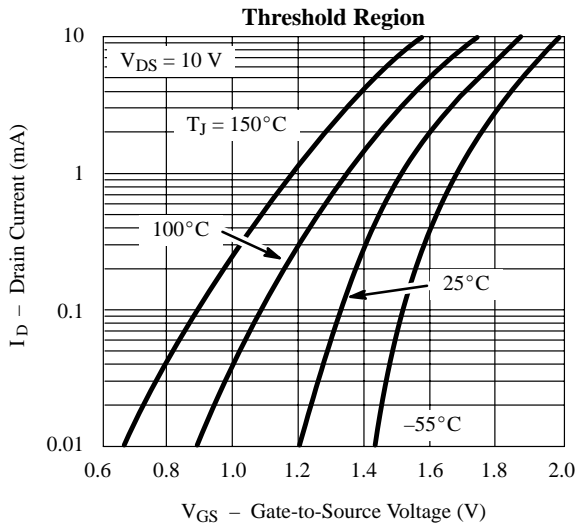

Typical Characteristics (25°C Unless Noted)

P-Channel

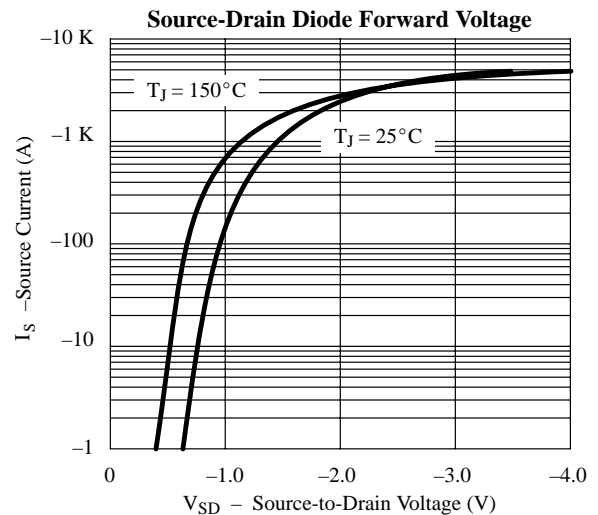
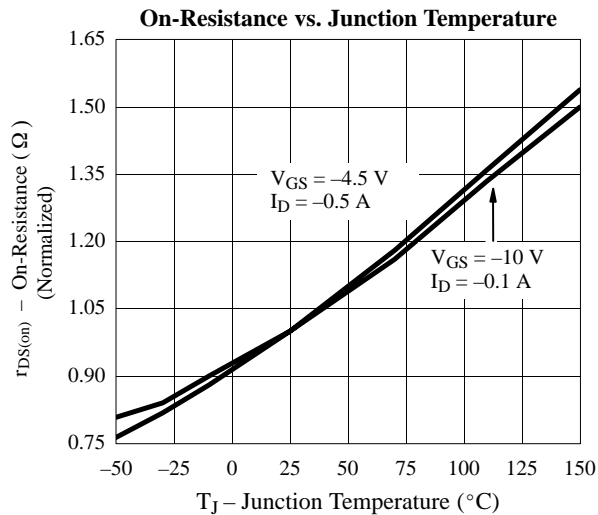
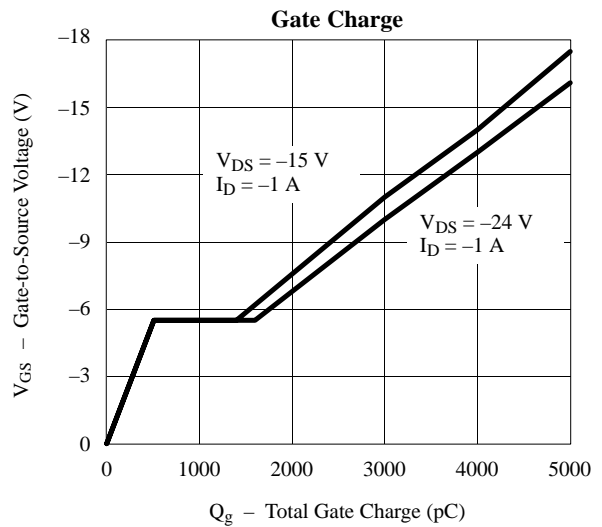
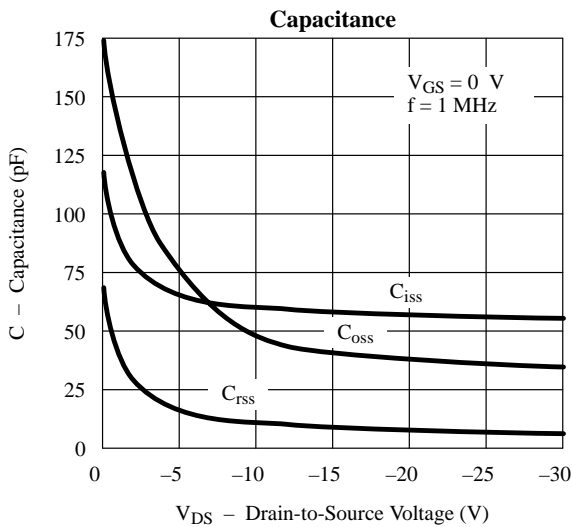
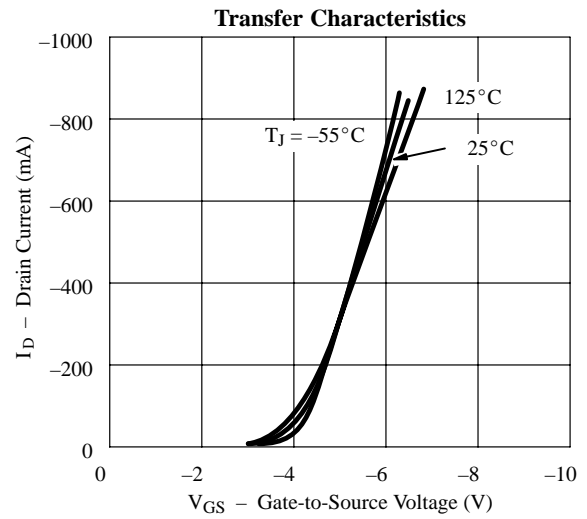
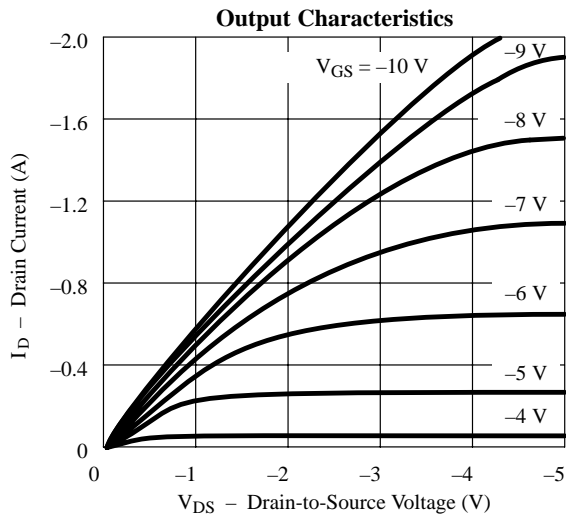

VQ3001J/3001P

Typical Characteristics (25°C Unless Noted)

P-Channel

