

PP39

**MAINTENANCE
MANUAL**

**Stag Microsystems Ltd
Martinfield
Welwyn Garden City
Herts AL7 1JT
United Kingdom**

**Tel: (0707) 332148
Fax: (0707) 371503**

**Stag Microsystems, Inc
1600 Wyatt Drive
Santa Clara, CA 95054
USA**

**Tel: (408) 988-1118
Fax: (408) 988-1232**

R E P L Y C A R D

In keeping with our Company policy of continuous enhancement this manual will be under constant review and will be updated when required. In order that the updated versions are addressed correctly could the following manual registration form be completed and returned for the attention of the Service Manager, Stag Electronic Designs Ltd.

QUESTIONNAIRE

User's Name

Title

Company

Address

.....

.....

Telephone..... Telex.....

Fax No.....

Type of machine to which the manual applies.....

Serial number.....

ERROR DETECTION

This maintenance manual is supplied as an enhancement to Stags co-ordinated international team effort.

Therefore, should any errors be detected, we would be grateful if you would contact us as soon as possible as to the nature of the mistake. Likewise if you would like to see improvements by adding your own ideas or modifications, then please do not hesitate to contact us at our Head Office in Welwyn Garden City.

PP39 Maintenance Manual

Using this manual

This manual consists of eight sections; each section covers a specific requirement that a Service Engineer may, at some time, need to know. This manual assumes that the Service Engineer is familiar with the operating procedures of the PP39 MOS Programmer, as detailed in the Operating Instruction Manual.

This manual is, wherever possible, laid out in easy to follow procedures. The performance check section provides a means of proving the correct functionality of a unit prior to despatch to a customer. The calibration procedure section enables a 'known good unit' to be calibrated. The maintenance procedure section consists of a series of tests enabling fault isolation within a failed unit.

Test Equipment Required

1. Oscilloscope eg Tektronic 2445
2. Digital Multi-meter eg Data Precision 2480R
3. 39M100 Module
4. 39M200 Module
5. Means of testing RS232C eg Another PP39.

CONTENTS

Section 1.0 Technical Description

- 1.1 Block Diagram
- 1.2 Processor
- 1.3 Clock Generator
- 1.4 Decoding
- 1.5 DRAM
- 1.6 Memory
- 1.7 EEPROM
- 1.8 Display
- 1.9 RS232 Interface
- 1.10 Display/Keyboard Control
- 1.11 LED/Analogue Control
- 1.12 Address/Data Pin Drives
- 1.13 Clamps Vcc, VP24, VP1 and Components
- 1.14 Pull Up Transistor
- 1.15 Pull Down Transistors
- 1.16 Power Up

Section 2.0 Performance Check

- 2.1 Check Software
- 2.2 Check Calibration
- 2.3 Check Keyboard
- 2.4 Check LED's
- 2.5 Check Display
- 2.6 Check EEPROM
- 2.7 Check DRAM
- 2.8 Check RS232C
- 2.9 Check Operation of ZIF Sockets
- 2.10 Check Check Programming Capability

Section 3.0 Calibration Procedure

- 3.1 Current Source Calibration
- 3.2 Voltage Clamp Calibration

Section 4.0 Maintenance Procedure

- 4.1 Test Mode
- 4.2 Test Display
- 4.3 Checksum System PROM
- 4.4 Display EEPROM Type
- 4.5 Test DAC's
- 4.6 Test OV Clamps
- 4.7 Test Current Generators
- 4.8 Test Address Lines
- 4.9 DRAM Test
- 4.10 Test Data Lines
- 4.11 Test RS232C
- 4.12 Test EEPROM
- 4.13 Boot EEPROM
- 4.14 Checksum Module EPROM
- 4.15 Calibrate
- 4.16 Access Time Calibration

Section 5.0 Parts List

5.1	Ordering Information	
5.2	Component Lists	
5.2.1	Mainboard	100-0021
5.2.2	Power Supply	100-0031
5.3	Items Lists	
5.3.1	PP39 Assembly	100-0000
5.3.2	PP39 Cover Moulding Assy	100-0003
5.3.3	PP39 Mainboard	100-0021
5.3.4	PP39 Base Assy	100-0002
5.3.5	PP39 Heatsink (8 TRS)	100-0015
5.3.6	PP39 Heatsink (3 TRS)	100-0016
5.3.7	PP39 Cableform Assy	100-0014
5.3.8	PP39 PSU Board	100-0031

Section 6.0 Component Location

6.1	Mainboard	100-0021
6.2	PSU Board	100-0031

Section 7.0 Circuit Diagrams

7.1	PP39 Mainboard	100-0021
7.2	PP39 PSU Board	100-0031
7.3	PP39 Mainboard (2816)	100-0021

Section 8.0 Module

8.1	39M100	
8.1.1	Component List	
8.1.2	Items List	
8.1.3	Circuit Diagram	
8.2	39M200	

1.0 Technical Description

This section should be read with reference to the illustrations and circuit diagrams in this manual. It describes the operation of the PP39 MOS Programmer.

1.1 Block Diagram

PP39 Main Board

This board provides the following functional circuit blocks which are subsequently referred to by their block names:

Function	Block Name
Processor	Z80
All clock and timing pulses	Clock Generator
Local DRAM storage	DRAM
EPROM and scratch-pad memory	Memory
EEPROM memory	EEPROM
Decoding for this board, module, and RAM extension, plus DRAM refreshing	Decoding/DRAM refresh
RS232 Interface	RS232 Interface
Alphanumeric display and driving electronics	Display
Peripheral interface for device data pin drivers and display/keyboard control.	Decoding/DRAM control
Peripheral interface for LEDs and analogue electronics control	LEDs/Analogue control
Peripheral interfaces for device address/data pins	Address/data pin drivers
5 to 28 V programmable voltage clamps	Clamp Vcc Clamp VP24 Clamp VP1
Voltage clamp overcurrent detector	Comparator
High voltage current supplies	Pull up transistors
5V pull ups and 0V clamping	Pull down transistors
Power Up reset	

1.2 Processor

The Z80 is an 8 bit processor which can address 64K bytes of memory directly. It is driven by a 2MHz clock and may run software resident on the same board or in the module.

Input	From	Output	Purpose
E	clock generator		all processor timing
/IRQ	RS232 interface		I/O transfer interrupt
/NMI	comparator		hardware fault interrupt
/RES	power-up		reset processor
		/RD	processor reading data
		/WR	processor writing data
		/MREQ	indicates valid address on address bus
		/RFSH	next /MREQ for refresh
		A-bus	address lines
		D-bus	bi-directional data

1.3 Clock Generator

The crystal oscillator provides a 16MHz square wave which is divided immediately to 4MHz and used for clocking of the J-K flip-flops. Subsidiary outputs provide all system timing including DRAM access and refreshing.

Input	From	Output	Purpose
PHI	16MHz Xtal		all timing from this
MREQ	Decoding		DRAM access and refresh
DAM	Decoding		DRAM decode
		E	2MHz system clock
		Q	quadrature of E
		CMUX	DRAM address multiplex
		/RAS	DRAM row select
		/CA	DRAM column select
		Q2	UART clock

1.4 Decoding

Any device on the Z80 data bus (memory chip, DRAM, PIA LSI device etc) receives a select signal when the Z80 wishes to access it for a data transfer. These select signals are obtained by comparing the state of the address bus with the pattern allocated for each device.

In addition certain miscellaneous logic functions are also performed.

All these functions are made by the use of a combination of TTL decoders and FPLA's. Refer to appendix 1 for instruction on reading FPLA tables.

Input	From	Output	Purpose
-------	------	--------	---------

1.5 DRAM

The on-board DRAM consists of 64K bytes for holding PROM data. This is constructed from eight 64K x 1 DRAMs banked into blocks of 16K bytes.

Input	From	Output	Purpose
A-bus	Z80		address DRAM within selected bank
D-bus	Z80		bi-directional data
RBD	Address Data Driver		select DRAM bank
RB1	Address Data Driver		select DRAM bank
/RAS	Clock Generator		DRAM array row select
/CAS	Decoding		DRAM array column select
/RWE	Decoding		DRAM array write enable

1.6 Memory

The mainframe EPROM contains the power up initialising software, keyboard, display and test software.

The scratchpad RAM provides 2K bytes of working RAM for temporary storage.

Input	From	Output	Purpose
/RD	Z80		processor reading
/WR	Z80		processor writing
/SPAD	Decoding		select scratch-pad RAM
/PROM	Decoding		select mainframe EPROM
D-bus	Z80		bi-directional data
A-bus	Z80		address lines

1.7 EEPROM

The EEPROM is used to save machine parameters, built up using certain 'SET' functions, after the power has been removed. The initialisation software copies the EEPROM into the scratch-pad RAM at power up.

On earlier boards the EEPROM was a 2817 requiring additional electronics for its operation. On later boards a 2816A type EEPROM was fitted which needs no additional electronics.

Input	From	Output	Purpose
For both EEPROMs			
D-bus	Z80		bi-directional data
A-bus	Z80		address lines
/DR	Z80		processor reading
/WR	Z80		processor writing
/EE	Decoding		select EEPROM
Additionally for 2817			
		R/BU	indicates successful write
EPRM	REG 3		21V required to write to EEPROM turns on 21V to EEPROM

1.8 Display

This consists of a 16 character alpha numeric vacuum flourescent display driven by a multiplexing display controller. Control and data words are written to the controller serially. The negative voltages required to drive the display are derived from a dc to dc converter (IC3).

Input	From	Output	Purpose
RSD	Display/keyboard control		reset display controller
DAD	Display/keyboard control		serial data input
CLO	Display/keyboard control		clocks serial data
Display PSU (IC3)			
		Pin 3	approx -25V dc
		Pin 4	approx 2V rms -20V dc
		Pin 6	approx 2V rms -20V dc

1.9 RS232 Interface

This uses an LSI universal asynchronous receiver/transmitter (UART) to convert parallel 8-bit data to serial form. The UART is buffered and connected to the 25-way female connector.

Input	From	Output	Purpose
O2	clock generator		UART register selection
A1, A0	Z80		bi-directional data
D-bus	Z80		data direction control
R/W	decoding		internal timing of UART
/URT	decoding		UART select signal
/RES	power up		UART reset
		/IRQ	I/O interrupt to Z80
/RXD	25 way conn		pin 3
CTS	25 way conn		pin 5
DSR	25 way conn		pin 6
DCD	25 way conn		pin 8
		TXD	pin 2
		RTS	pin 4
		DTR	pin 20

1.10 Display/Keyboard Control

The display is controlled by sending serial data to the display controller over 'DAD' synchronised by a clocking signal on 'CLD'.

The keyboard consists of a matrix of columns and rows where pressing a key will make a connection between a particular row and column line. The PIA outputs a pattern to the columns and reads back the status of the rows. From this, the processor can calculate the key pressed.

PROTA of the PIA connects onto the RD-bus as described in the Address/Data Pin Driver section.

The inputs to and outputs from this block are defined in the following table:

Input	From	Output	Purpose
A0, A1	Z80		PIA register selection
D-bus	Z80		bi-directional data
PORT4	decoding		select PIA
RES	power-up		reset PIA registers
Pins 14-17	CONN K		to keyboard row lines
		Pin 13	to keyboard column line
		Pin 18-25	to keyboard column lines
		DAD	serial data to display controller
		CLD	clocking data on DAD
		RSD	display controller reset
		RD-bus	bi-direction data to device data pins

1.11 LED/Analogue Control

This PIA is mainly used for control of the analogue driving electronics ie pull up transistors, clamps and pull down transistors. Additional functions are included in the table below:

Input	From	Output	Purpose
A0, A1	Z80		PIA register selection
D-bus	Z80		bi-directional data
PORT1	decoding		select PIA
RES	power up		reset PIA registers
R/80	EEPROM		indicates successful EEPROM write *
CTS	RS232 interface		RS232 handshake signal
		L28	module LED's
		L24	module LED's
		R24	module LED's
		R28	module LED's
		EPRM	controls EEPROM hi voltage *
		CON	turns on clamps Vcc, VP1 and VP24
		EDG	access time control
		DX1-DX4	controls pull down transistors a, b, c and d
		Y1-Y7	controls all pull up transistors

* signal only applies to boards fitted with 2817 EEPROM.

1.12 Address/Data Pin Drivers

These two PIA's are used mainly for driving device address pins and driving/sensing device data pins. Additional functions are included in the table below:

Input	From	Output	Purpose
A0, A1	Z80		PIA register selection
D-bus	Z80		bi-directional data
PORT2	decoding		select PIA
PORT3	decoding		select PIA
RES	power-up		reset PIA registers
		PA-bus	drive device address pins
		QA9, 11, 13	controls pull down transistors e, f and g
		LD-bus	bi-directional data to device data pins
		RD-bus	bi-directional data to device data pins
		RB-bus	select DRAM bank
		WAGL	control 10K pull ups on LD-bus
		WAGR	control 10K pull ups on RD-bus
		BLP	control bleeper

1.13 Clamps Vcc, VP24, VP1 and comparator

As all three DAC's are practically identical only one needs to be described, clamp Vcc.

The DAC latches on 8-bit value written to it by the processor and produces a negative voltage proportional to it at pin 16 of the DAC. An error voltage at pin 5 of the op amp is amplified and used to control the current sink TR9. This controls whether current is flowing into C30 from TR11 or out of C30 into TR9 and hence the voltage across C30. The clamp transistor TR13 provides current gain and sets the clamp output voltage.

The voltage at the collector of TR13 is determined by R24 and is used by the comparator to detect an over current fault which then generates an/NMI.

The inputs to and outputs from this block are defined in the following table:

Input	From	Output	Purpose
D-bus	Z80		bi-directional data
/WR	Z80		processor writing
/DAC1	decoding		select DAC1
/DAC2	decoding		select DAC2
/DAC3	decoding		select DAC3
		VCC	clamps collector of pull up transistors
		VP24	clamps collector of pull up transistors
		VP1	clamps collector of pull up transistors
		/NMI	indicate to Z80 hardware fault

1.14 Pull Up Transistors

The function of these is to take a device pin to a high voltage. Pull up transistors associated with outputs b and g are connected to the +15V rail as opposed to +32V used on outputs a, c, d, e and f.

The inputs to and outputs from this block are defined in the following table:

Input	From	Output	Purpose
Y1-Y7	LED/analogue control		control of pull up transistors
		a to g	high voltage pin drivers

1.15 Pull Down Transistors

These enable outputs a to g to be clamped to 0V. These outputs go directly to the module.

The inputs to and outputs from this block are defined in the following table:

Input	From	Output	Purpose
DX1-DX3	LED/analogue control		control of pull down transistors
QA9, 11, 13	Address/data pin drivers		control of pull down transistors
		a to g	high voltage pin drivers

1.16 Power Up

Application of mains power produces a long pulse on the /RES and RES lines which initialises the Z80, UART and ports.

The inputs to and outputs from this block are defined in the following table:

Input	From	Output	Purpose
application of power			charges C22 through R10
		RES	high power-on pulse
		/RES	low power-on pulse

I 12V Supply

Provides a regulated I 12V supply for the RS232 interface and certain of the pull up transistors.

2.0 Performance Check

This section of the manual describes a method of checking that a PP39 MOS Programmer is functioning correctly. These tests should be carried out prior to despatch to a customer. However, these procedures should only be used as a final test and, should any test fail, please refer to section 4 - Maintenance Procedures.

2.1 Check Software

2.1.1 Check Software Revision

Remove any module for PP39

POWER ON

Display will read MODULE?

Press SET Key

Press 6 keys

Display will read PP39 Iss XX

Where xx is the revision of the mainframe software

Ensure that this is the appropriate revision.

POWER OFF

Insert module and repeat procedure above to check revision of module.

Display read "Module Mx00 XX"

Where x is the module number

Repeat for any other modules

2.1.2 Check Software Checksums

Access Test Mode

Key sequence SET, HIDDEN KEY (Between LOAD and EDIT) A, B, A

Display should read TEST ENTER - -

Select test 05

The checksum of the system eeprom will be displayed - Ensure this agrees with the issue.

Press EXIT

Display will read TEST ENTER - -

Select test 85

The checksum of the module eeprom will be displayed - Ensure this agrees with the issue.

Repeated for any other modules

2.2 Check Calibration

The nature of the circuitry of the PP39, requires the PP39 to be dismantled for Calibration Checking; to do this proceed as follows:-

1. Disconnect unit from mains supply.
2. Remove from base of unit the three screws nearest the front, which secure the base to the cover moulding.
3. Remove from the rear panel the two screws nearest the top corners.
4. Carefully separate the cover moulding from the base assembly.

NOTE 1: The power supply is mounted on the base and is connected to the mainboard via a cableloom assembly.

5. Place the unit such that the two halves are still electrically connected by the cableloom assembly and access can be made of the pcb's.
6. Reconnect to switchable mains supply and insert 39M100 then switch on.
7. The following procedure checks the correct calibration of the current source of the PP39.

Press SET key
Press HIDDEN key - between LOAD and EDIT keys
Press A key
Press B key
Press A key - Display will read TEST ENTER - -
Select test 86

The display will now be CALIBRATE

Measure the voltages across R88 then R84 and check for 2.70V + or - 0.1V

8. The following procedure checks the correct voltage calibration of the clamps.

Check the voltages and ensure they conform to the table below:-

Test Point	Measured Voltage	Tolerance
D9 Anode (TP1)	12.5V	+ or - 0.01V
D15 Anode (TP2)	12.5V	+ or - 0.01V
D16 Anode (TP3)	6.00V	+ or - 0.01V

Note 1: Use negative end of capacitor C22 for 0V reference of voltmeter.

2.3 Check Keyboard

Remove Module

POWER ON

Display will read **MODULE?**

Press each key in turn and ensure the horn will sound at each key press

This proves the contacts of all the keys of the membrane panel.

However, to prove the PP39 can interpret the correct keys, it is advisable to power off, insert a module, power on, and check the unit responds correctly as each key is pressed. (Refer to Operating Instruction Manual).

2.4 Check LED's

The procedure below describes the method of checking correct LED control for the 39M100. A similar technique should be used for any other available module.

PP39/39M100 LED's

Install 39M100

Power On

Press **SET** key

Press **0** key

Press **DOWN ARROW** key **ONCE**

Press **EXIT** key

Press **SET** key

Press **3** key

Press **DOWN ARROW** key or **UP ARROW** key

Display shows **MODE 8 BIT**

Press **EXIT** key

The display should read **AMD 2716 M8** and the Two LEDs in relation to the 24 pin device on each socket, should illuminate **only**.

Press **SET** key

Press **0** key

Press **RIGHT ARROW** key **SIX TIMES**

Press **EXIT** key

The display should now read **AMD 27128 M8** and the Two LEDs in relation to the 28 pin device, on each socket, should illuminate **only**.

Press **SET** key

Press **0** key

Press **LEFT ARROW** key **THREE TIMES**

Press **EXIT** key

The horn should sound and the display will read **RAM EXCEEDED**, then the LED for right socket will **EXTINGUISH** only and the display will read **AMD 27512 M8**.

2.5 Check Display

Access test mode (keysequence is SET, HIDDEN KEY (between LOAD and EDIT), A, B, A)

Display will read TEST ENTER - -
Select test 00
Display should read *****
Press EXIT
Select test 01
Display should read 0000000000000000
Press EXIT
Select test 02
Display should scroll a * from right to left
Press EXIT
Select test 03
Display should scroll a 0 from right to left
Press EXIT

2.6 Check EEPROM

Access test mode (key sequence SET, HIDDEN KEY (between LOAD and EDIT), A, B, A)

Display will read TEST ENTER - -
Select test 0D
Display will read EET (EEPROM Test)
After approximately 25 seconds display
Display will read PASS
Press EXIT
Display will read TEST ENTER - -
Select test 84 (Module must be inserted)
Display will read EEPROM BOOT then return to TEST ENTER - -

This is essential to execute this boot after an EEPROM TEST to re-configure valid EEPROM data.

2.7 Check DRAM

Access test mode
Select test 0B
Display should read DRA and after a period of time PASS
Press EXIT

2.8 Check RS232C

The UART can quickly be checked by a selftest.

LINK PIN 2 to PIN 3 of RS232C connector
Access TEST MODE
Select test 0E
Display should read IFA then PASS

2.9 Check Operation of ZIF Sockets

For this test two EPROMs are required 1 x 24 pin and 1 x 28 pin both with known checksums.

Using a 24 pin programmed EPROM (with known C/SUM, eg 2716) proceed as follows:-

Press SET 0
Using UP and DOWN cursor keys locate **manufacturer** of device
Using LEFT and RIGHT cursor keys locate **device type**
Insert device into SKT 1
Press LOAD key
Display should read **XXXX CSUM**
(where XXXX = checksum of device)
Place same device in SKT 2
Press LOAD key
Display should read **CSUM XXXX**
(where XXXX = checksum of device)
Press C/SUM key
Display should read **XXXX CSUM XXXX**
and both checksums should be the same
Remove 24 pin device and repeat for 28 pin EPROMs

2.10 Check Programming Capability

Using the 28 pin programmed EPROM (with known C/SUM, eg 27128) proceed as follows:-

Press SET 0
Using UP and DOWN cursor keys locate **manufacturer** of device
Using LEFT and RIGHT cursor keys locate **device type**
Insert master device into SKT 1
Press LOAD key
Display will read **XXXX CSUM**
Remove device from socket and place in SKT 2
Press LOAD key
Display will read **CSUM XXXX**
Remove master from socket 2
Press C/SUM key
Display will read **XXXX CSUM XXXX**
Insert two suitable **empty** devices into the sockets
Press **EMPTY** key
Display will read **PASS EMPTY PASS**
Press **PROGRAM** key
Display will read **PASS BIT TEST PASS**
Then change to **PROGRAMMING XX**
where xx is a counter up to 40 in Hex (If 27128)
Then change to **PASS VERIFY PASS**

3.0 Calibration Procedure

To correctly calibrate the PP39 proceed as follows:-

Section 2.2 describes access to the calibration points and explains how to check calibration.

With reference to this section and the table below the calibration can be adjusted.

3.1 Current Source Calibration

Voltage Across R88 = 2.7V + or - 0.01V Adjust
RV1 on PSU

3.2 Voltage Clamp Calibration

Test Point	Measured Voltage	Tolerance	Adjust
D9 Anode (TP1)	12.5V	+ or - 0.01V	VR1
D15 Anode (TP2)	12.5V	+ or - 0.01V	VR3
D16 Anode (TP3)	6.00V	+ or - 0.01V	VR2

on Main Board

4.0 Maintenance Procedure

To aid the Service Engineer the PP39 has several test routines, which allow various parts of the circuitry to be more easily tested.

4.1 Test Mode

To gain access to the test routines it is necessary to enter a coded sequence of key presses. This is arranged like this to prevent a customer accidentally executing a test when a device is fitted into a ZIF socket.

The following instructions permit access to the test mode:-

Press SET key
Press HIDDEN key
Press A key
Press B key
Press A key

The display will now read ENTER TEST - -

The tests available can be split into two categories:-

1. Mainframe test - test numbers 00 to 7F.
2. Module execute tests - test number 80 to FF.

Note: Whilst in test mode the LIST RAM, EDIT RAM functions actually permit access to the 'REAL' address map of the PP39 ie. control latches etc can be written/read directly from the keyboard.

4.2 Test Display

There are four display patterns, this test continuously write to the display controller the screen pattern of instructions, thus if an incorrect display is present it is possible to fault find using an oscilloscope etc.

Test 00 - Displays a * in all 16 display positions
Test 01 - Display a 0 in all 16 display positions
Test 02 - Displays a single * and scrolls this from right to left
Test 03 - Display a single 0 and scrolls this from right to left.

4.3 Display EEPROM Type

Test 04 EET

The PP39 was originally designed to empty a 2817 type of EEPROM, however, this has now been changed to type 2816. The later device can be programmed more quickly, than the original. Hardware modifications have been made to the EEPROM circuitry to suit the 2817 EEPROM.

However, to simplify software issues (ie only one EPROM independant of type of EEPROM), the programming of the EPROM defaults to the longer programming cycle, unless it reads from the EEPROM that it is type 2816 and in this case it runs the faster algorithm.

Test 04 attempts to write to the EEPROM using the faster algorithm and if successfully stored, the display shows 2816 otherwise it shows 2817.

After this test has been executed the faster algorithms will always be used (if applicable).

4.4 Checksum System PROM

Test 05 SYS CSUM

This test checksums and displays the system EPROM.

4.5 Test DAC's (Digital to Analogue Convertors)

Test 06 Ramping DACs

This test ramps all the DAC's in a continued loop.

Set oscilloscope to 1ms/Div; 2 volts/Div check the waveforms, at pin 16 of IC's 42, 44 an 46, agree to that shown below:-

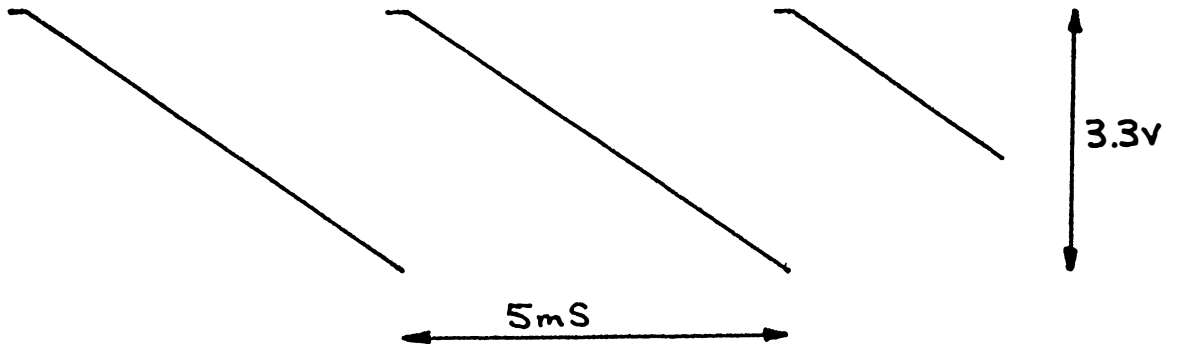

Test 07 Bit Walk DAC's

This test writes the pattern 01, 02, 04, 08, 10, 20, 40, 80 continuously to the DAC's.

Set oscilloscope to 50mS/Div, 2 volts/Div and compare the waveforms at pin 16 of IC's 42, 44 and 46 with that shown below:-

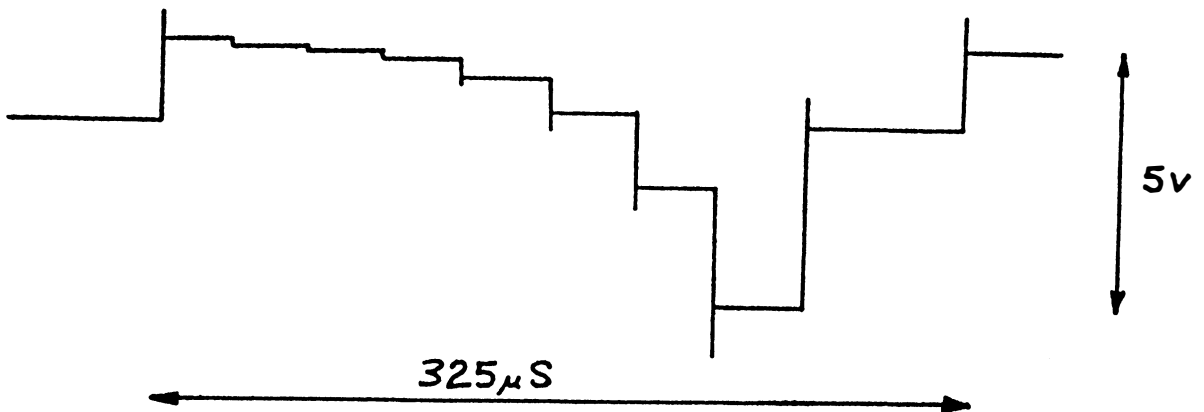

4.6

Test 0V Clamps

Test 08 0V Clamp Walk

This test the sequences of the 0V clamps, set the oscilloscope to 50mS/Div, 1 Volt/Div and compare the waveforms, of pin 14, IC33 (DX1); in 15 IC33 (DX2), and pin 16 IC33 (DX3), with that shown below:-

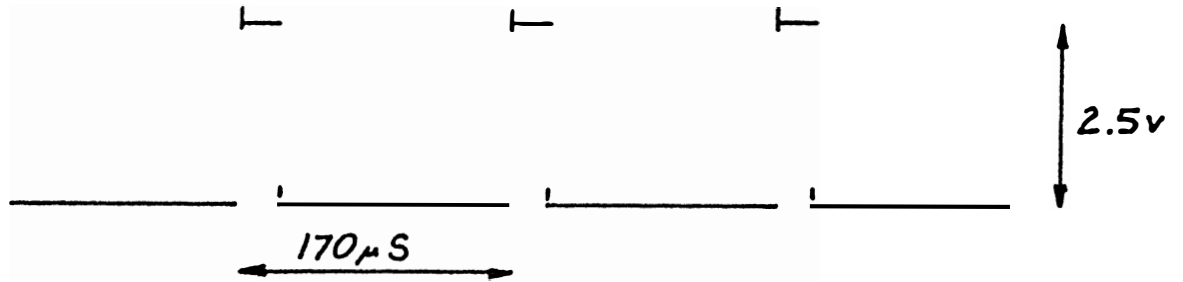

Also check waveform at pin 17 IC33 (DX4) and compare with that shown below:-

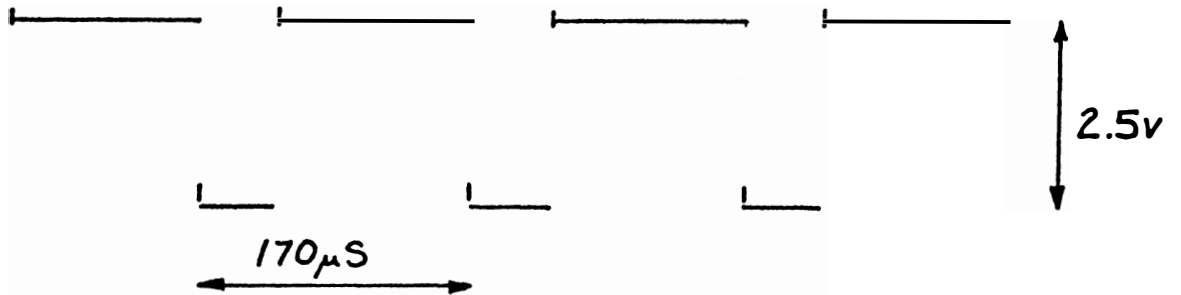

Pin's 12 of IC34 (QA13), 15 (QA9) and 17 (QA11) with that shown below:-

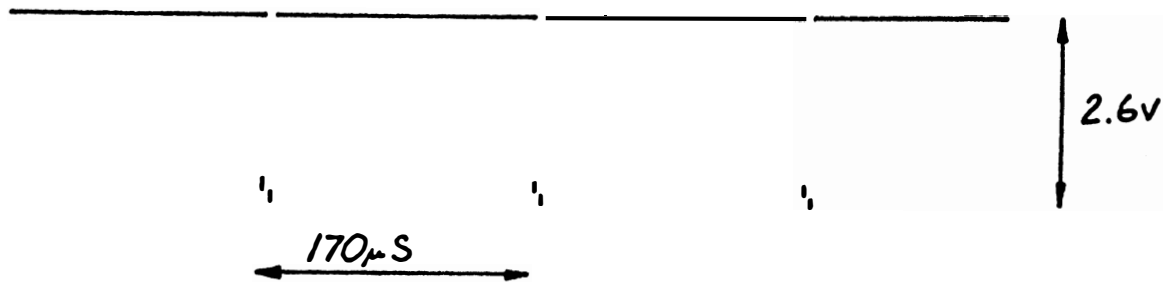

4.7 Test Current Generators

Test 09 Current Gen Walk

Set oscilloscope to 50mS/Div, 1 volt/Div and compare the waveform below to that measured on pins 1^o (Y1), 19 (Y2), 20 (Y3), 21 (Y4), 22 (Y5), 23 (Y6) and 24 (Y7) of IC33.

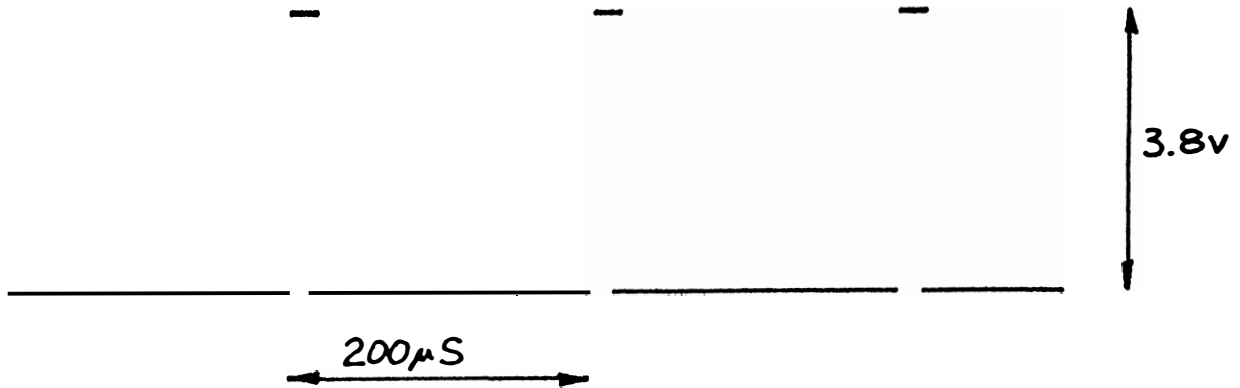

4.8 Test Address Lines

Test 0A Bit Walk Address

This test writes a pattern to both the high address and the low address lines at the same time; set oscilloscope to 50mSec/Div, 1 Volt/Div and compare the associated measurement with those shown in the diagrams overleaf:-

IC34 pins 10 (pa15), 25 (pa7)

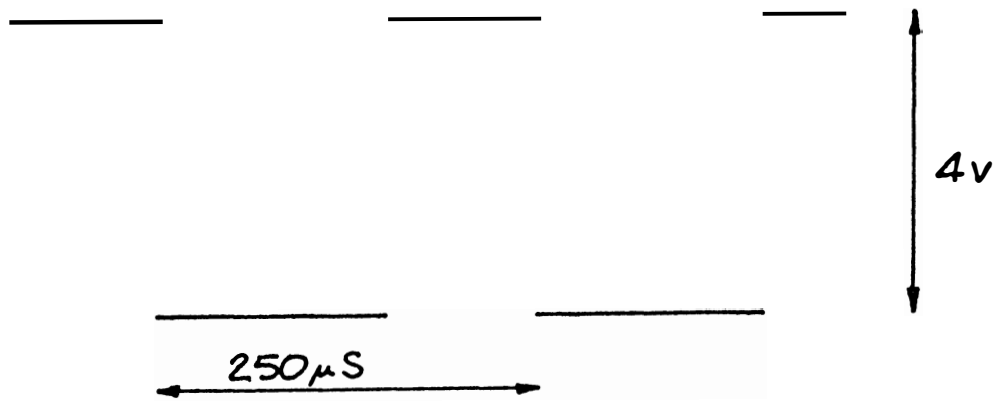

IC34 pins 15 (Qa9), 17 (Qa11)

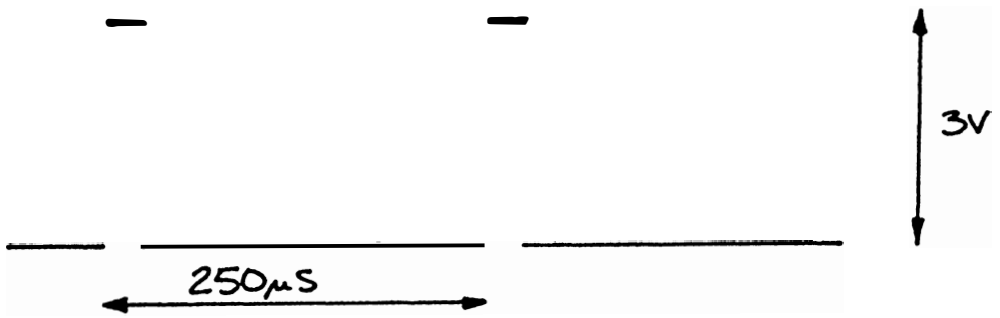

IC34 pin 12 (Qa13)

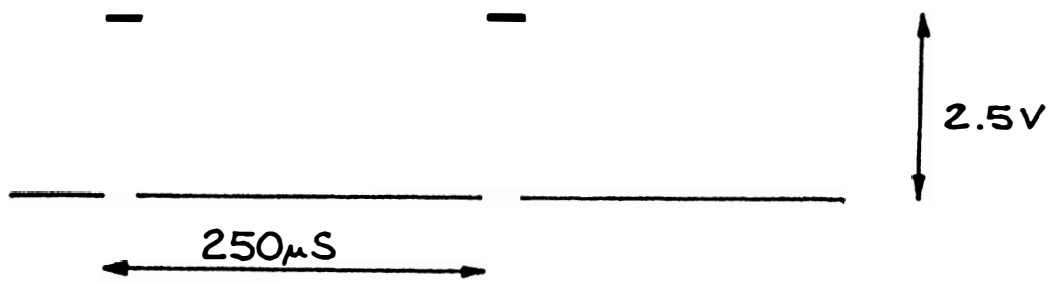

IC34 pins 11 (PA13), 13 (PA12), 14 (PA7), 16 (PA8), 18 (PA0), 19 (PA1), 20 (PA2), 21 (PA3), 22 (PA4), 23 (PA5) and 24 (PA6).

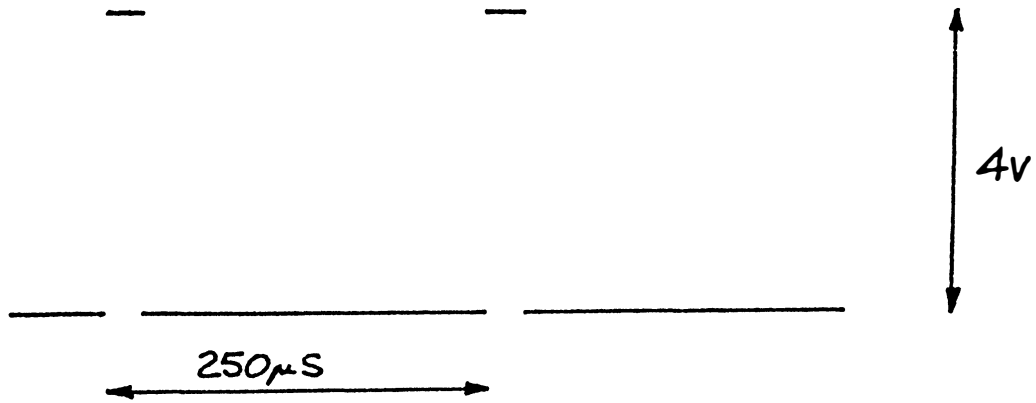

4.9 DRAM Test

Test OB DRA

This test checks the DRAM by writing and reading from the DRAM. If a failure occurs the display will show the failed address the expected result and the actual result. Also at this time the microprocessor is continuously looping at this RAM address.

Example of failures:

004000	00	-	46
Address	Expected Result		Actual Result

If the RAM test is successful the display will read PASS. A familiar location can be skipped by using the down cursor key at the test will continue to the next failure (if any).

4.10 Test Data Lines

Test OC LDR

This selftest writes to and reads back the data pin drivers. Again should a failure occur the display will show both the expected and the actual result and the processor loops on this test eg.

3A	>	2A	02	-	06
O/P Port		I/P Port	Data Sent		Data Received

Press the down cursor key to skip through test.

4.11 Test RS232C

Test OE IFA

This test requires pins 2 and 3 of RS232C to be limited. It performs a series of tests checking the Uart parameters. Obviously, this test is not proof of correct RS232C operation and this must be checked connected to a system. However this test is useful for fault diagnosis.

A typical failure result is shown here.

CC - 91 6B S-16

Where CC is 1. Control register 2, Command register
91 is data of Control register
6B is data of Command register
S-16 is Status register

The following tables show details of these registers.

Note: using the down cursor you can skip a failure in the test and continue to the next failures (if any).

CONTROL REGISTER

"Cc-91 6B S-16"

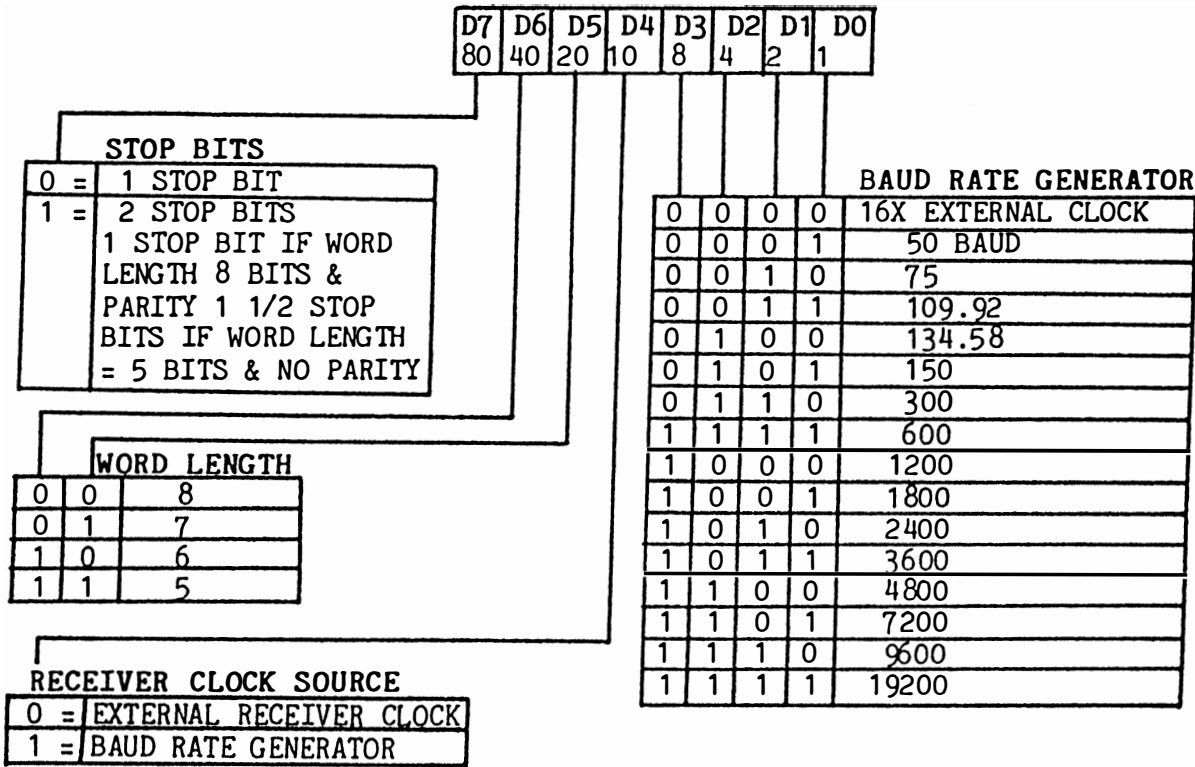

COMMAND REGISTER

"cC-91 6B S-16"

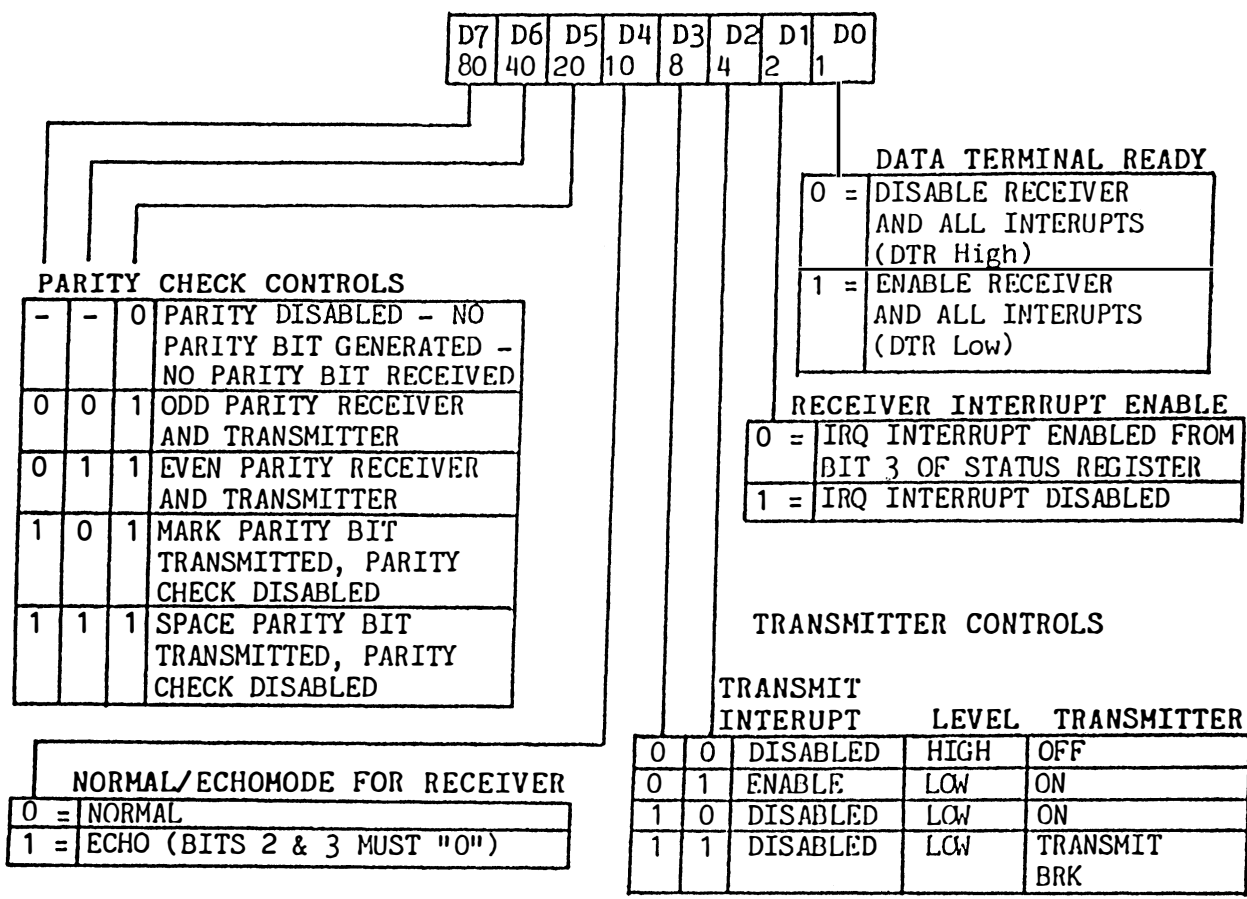

STATUS REGISTER

"Cc-91 6B S-16"

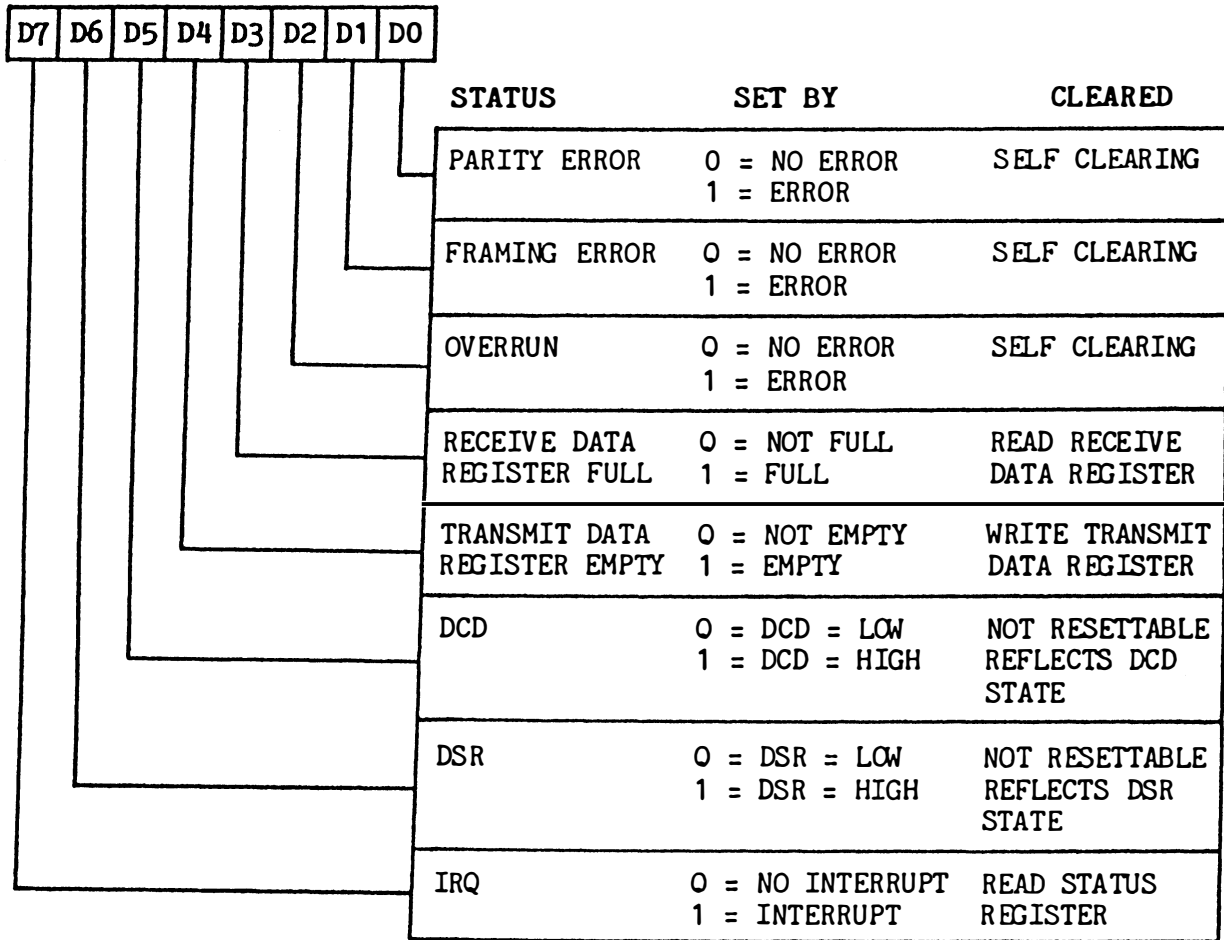

4.12 Test EEPROM

Test OD EET

This test checks the EEPROM, however should a failure occur this test does not loop (to preserve EEPROM life time).

A typical failure would be:-

2840 BC - FC

When 2840 is the failing address
BC is the written data
FC is the read data

The down cursor key continues the test to the next failure (if any).

4.13 Boot EEPROM

Test 84

This test 'boots' the EEPROM with valid parameters applicable to the module fitted. This test must be executed for consistent module operation. Otherwise a series of store operations must be made.

4.14 Checksum Module EPROM

Test 85

This test checksums the module EPROM.

4.15 Calibrate

Test 86

Please refer to calibrate procedure

4.16 Access Time Calibrate

Test 87

Using an oscilloscope set to 0.1mS/Div, 1 Volt/Div. Adjust RV1 on 39M100 module (only) whilst monitoring module test point 1 and check time period varies from approx 0.05mS to 0.55mS.

5.2 Component Lists

5.2.1	Mainboard PCB	100-0021
5.2.2	Power Supply	100-0031

COMPONENT LIST 100-0021 PP39 PCB ISSUE 6

C 14	123 100	CAP MULTILAYER CERAMIC 0.1uF 50V
C 15	123 100	CAP MULTILAYER CERAMIC 0.1uF 50V
C 16	123 100	CAP MULTILAYER CERAMIC 0.1uF 50V
C 17	123 100	CAP MULTILAYER CERAMIC 0.1uF 50V
C 18	123 100	CAP MULTILAYER CERAMIC 0.1uF 50V
C 19	123 100	CAP MULTILAYER CERAMIC 0.1uF 50V
C 20	123 100	CAP MULTILAYER CERAMIC 0.1uF 50V
C 21	123 100	CAP MULTILAYER CERAMIC 0.1uF 50V
C 22	110 043	CAP AL ELEC AXIAL 47uF 10V
C 23	123 100	CAP MULTILAYER CERAMIC 0.1uF 50V
C 24	120 104	CAP RESIN DIPPED TANT 1.5uF 35V
C 25	123 100	CAP MULTILAYER CERAMIC 0.1uF 50V
C 27	123 100	CAP MULTILAYER CERAMIC 0.1uF 50V
C 28	123 100	CAP MULTILAYER CERAMIC 0.1uF 50V
C 29	123 474	CAP MULTILAYER CERAMIC 0.47uF 50V
C 30	123 474	CAP MULTILAYER CERAMIC 0.47uF 50V
C 31	123 100	CAP MULTILAYER CERAMIC 0.1uF 50V
C 32	123 100	CAP MULTILAYER CERAMIC 0.1uF 50V
C 33	123 474	CAP MULTILAYER CERAMIC 0.47uF 50V
C 34	123 100	CAP MULTILAYER CERAMIC 0.1uF 50V
C 35	123 100	CAP MULTILAYER CERAMIC 0.1uF 50V
C 36	123 100	CAP MULTILAYER CERAMIC 0.1uF 50V
C 37	123 100	CAP MULTILAYER CERAMIC 0.1uF 50V
C 38	123 100	CAP MULTILAYER CERAMIC 0.1uF 50V
C 39	124 562	CAP MULTILAYER CERAMIC 5600pF 50V
C 41	124 102	CAP MULTILAYER CERAMIC 1000pF 50V
X 1	308 003	CRYSTAL 1.8432 MHZ
M 1	100-0022	PP39 PCB
M 2	309 165	DISPLAY FIP 16A5R
M 5	400 060	SOLDER PIN D/S
M 6	400 060	SOLDER PIN D/S
M 7	400 060	SOLDER PIN D/S
M 8	400 060	SOLDER PIN D/S
M 9	100-0014	PP39 CABLE FORM ASSY
M 17	318 764	E PROM 2764
M 24	400 060	SOLDER PIN D/S
M 25	400 060	SOLDER PIN D/S
M 26	400 060	SOLDER PIN D/S
M 27	400 060	SOLDER PIN D/S
M 28	400 060	SOLDER PIN D/S
M 29	400 060	SOLDER PIN D/S
M 30	400 060	SOLDER PIN D/S

COMPONENT LIST 100-0021 PP39 PCB ISSUE 6

R 92	132	100	RESISTOR CARBON FILM 0.5W 5% 10R
R 93	131	681	RESISTOR CARBON FILM 0.25W 5% 680R
R 94	131	272	RESISTOR CARBON FILM 0.25W 5% 2K7
R 95	131	272	RESISTOR CARBON FILM 0.25W 5% 2K7
R 96	131	333	RESISTOR CARBON FILM 0.25W 5% 33K
R 97	135	180	RESISTOR THICK FILM 0.5W 2% 18R
R 98	135	180	RESISTOR THICK FILM 0.5W 2% 18R
R 99	135	270	RESISTOR THICK FILM 0.5W 2% 27R
D 1	288	107	DIODE ZENER 1.3W BZX 61 C15V
D 2	284	148	DIODE 1N4148
D 3	284	148	DIODE 1N4148
D 5	284	148	DIODE 1N4148
D 6	284	148	DIODE 1N4148
D 7	284	148	DIODE 1N4148
D 8	284	148	DIODE 1N4148
D 9	284	148	DIODE 1N4148
D 10	284	148	DIODE 1N4148
D 11	284	148	DIODE 1N4148
D 12	284	148	DIODE 1N4148
D 13	284	148	DIODE 1N4148
D 14	284	148	DIODE 1N4148
D 15	284	148	DIODE 1N4148
D 16	284	148	DIODE 1N4148
D 17	284	148	DIODE 1N4148
D 18	284	148	DIODE 1N4148
D 19	284	148	DIODE 1N4148
D 20	284	148	DIODE 1N4148
D 21	284	148	DIODE 1N4148
D 22	284	148	DIODE 1N4148
D 23	284	148	DIODE 1N4148
D 24	284	148	DIODE 1N4148
D 25	284	148	DIODE 1N4148
D 26	284	148	DIODE 1N4148
D 27	284	148	DIODE 1N4148
D 28	284	148	DIODE 1N4148
D 29	284	148	DIODE 1N4148
D 30	284	148	DIODE 1N4148
D 31	284	148	DIODE 1N4148
D 32	284	148	DIODE 1N4148
D 33	284	148	DIODE 1N4148
D 34	284	148	DIODE 1N4148
D 35	284	148	DIODE 1N4148
D 36	284	148	DIODE 1N4148
D 37	284	148	DIODE 1N4148
D 38	284	148	DIODE 1N4148
D 39	284	148	DIODE 1N4148
D 40	284	148	DIODE 1N4148
C 1	110	007	CAP AL ELEC RADIAL 1uF 63V
C 2	110	007	CAP AL ELEC RADIAL 1uF 63V
C 3	123	100	CAP MULTILAYER CERAMIC 0.1uF 50V
C 4	110	044	CAP AL ELEC AXIAL 100uF 10V
C 5	123	100	CAP MULTILAYER CERAMIC 0.1uF 50V
C 6	120	104	CAP RESIN DIPPED TANT 1.5uF 35V
C 7	123	100	CAP MULTILAYER CERAMIC 0.1uF 50V
C 8	123	100	CAP MULTILAYER CERAMIC 0.1uF 50V
C 9	120	104	CAP RESIN DIPPED TANT 1.5uF 35V
C 10	123	011	CAP CERAMIC PLATE 470pF 63V
C 11	123	011	CAP CERAMIC PLATE 470pF 63V
C 12	123	011	CAP CERAMIC PLATE 470pF 63V
C 13	123	011	CAP CERAMIC PLATE 470pF 63V

COMPONENT LIST 100-0021 PP39 PCB ISSUE 6

R 32	131	473	RESISTOR	CARBON	FILM	0.25W	5%	47K
R 33	131	471	RESISTOR	CARBON	FILM	0.25W	5%	470R
R 34	131	331	RESISTOR	CARBON	FILM	0.25W	5%	330R
R 35	131	102	RESISTOR	CARBON	FILM	0.25W	5%	1K0
R 36	131	682	RESISTOR	CARBON	FILM	0.25W	5%	6K8
R 37	131	151	RESISTOR	CARBON	FILM	0.25W	5%	150R
R 38	131	102	RESISTOR	CARBON	FILM	0.25W	5%	1K0
R 39	131	332	RESISTOR	CARBON	FILM	0.25W	5%	3K3
R 40	131	473	RESISTOR	CARBON	FILM	0.25W	5%	47K
R 41	131	471	RESISTOR	CARBON	FILM	0.25W	5%	470R
R 42	131	102	RESISTOR	CARBON	FILM	0.25W	5%	1K0
R 43	131	681	RESISTOR	CARBON	FILM	0.25W	5%	680R
R 44	131	102	RESISTOR	CARBON	FILM	0.25W	5%	1K0
R 45	131	102	RESISTOR	CARBON	FILM	0.25W	5%	1K0
R 46	131	332	RESISTOR	CARBON	FILM	0.25W	5%	3K3
R 47	131	473	RESISTOR	CARBON	FILM	0.25W	5%	47K
R 48	131	471	RESISTOR	CARBON	FILM	0.25W	5%	470R
R 49	131	331	RESISTOR	CARBON	FILM	0.25W	5%	330R
R 50	131	102	RESISTOR	CARBON	FILM	0.25W	5%	1K0
R 51	131	682	RESISTOR	CARBON	FILM	0.25W	5%	6K8
R 52	131	151	RESISTOR	CARBON	FILM	0.25W	5%	150R
R 53	131	331	RESISTOR	CARBON	FILM	0.25W	5%	330R
R 54	131	561	RESISTOR	CARBON	FILM	0.25W	5%	560R
R 55	131	102	RESISTOR	CARBON	FILM	0.25W	5%	1K0
R 56	131	272	RESISTOR	CARBON	FILM	0.25W	5%	2K7
R 57	131	272	RESISTOR	CARBON	FILM	0.25W	5%	2K7
R 58	131	471	RESISTOR	CARBON	FILM	0.25W	5%	470R
R 59	131	681	RESISTOR	CARBON	FILM	0.25W	5%	680R
R 60	131	271	RESISTOR	CARBON	FILM	0.25W	5%	270R
R 61	131	331	RESISTOR	CARBON	FILM	0.25W	5%	330R
R 62	131	272	RESISTOR	CARBON	FILM	0.25W	5%	2K7
R 63	131	102	RESISTOR	CARBON	FILM	0.25W	5%	1K0
R 64	131	272	RESISTOR	CARBON	FILM	0.25W	5%	2K7
R 65	131	272	RESISTOR	CARBON	FILM	0.25W	5%	2K7
R 66	131	272	RESISTOR	CARBON	FILM	0.25W	5%	2K7
R 67	131	272	RESISTOR	CARBON	FILM	0.25W	5%	2K7
R 68	131	102	RESISTOR	CARBON	FILM	0.25W	5%	1K0
R 69	131	822	RESISTOR	CARBON	FILM	0.25W	5%	8K2
R 70	131	822	RESISTOR	CARBON	FILM	0.25W	5%	8K2
R 71	131	472	RESISTOR	CARBON	FILM	0.25W	5%	4K7
R 72	131	682	RESISTOR	CARBON	FILM	0.25W	5%	6K8
R 73	131	392	RESISTOR	CARBON	FILM	0.25W	5%	3K9
R 74	131	272	RESISTOR	CARBON	FILM	0.25W	5%	2K7
R 75	131	392	RESISTOR	CARBON	FILM	0.25W	5%	3K9
R 76	131	681	RESISTOR	CARBON	FILM	0.25W	5%	680R
R 77	131	272	RESISTOR	CARBON	FILM	0.25W	5%	2K7
R 78	131	102	RESISTOR	CARBON	FILM	0.25W	5%	1K0
R 79	131	272	RESISTOR	CARBON	FILM	0.25W	5%	2K7
R 80	131	472	RESISTOR	CARBON	FILM	0.25W	5%	4K7
R 81	134	560	RESISTOR	METAL	FILM	0.25W	1%	56R
R 82	131	102	RESISTOR	CARBON	FILM	0.25W	5%	1K0
R 83	131	682	RESISTOR	CARBON	FILM	0.25W	5%	6K8
R 84	135	270	RESISTOR	THICK	FILM	0.5W	2%	27R
R 85	134	560	RESISTOR	METAL	FILM	0.25W	1%	56R
R 86	135	270	RESISTOR	THICK	FILM	0.5W	2%	27R
R 87	135	270	RESISTOR	THICK	FILM	0.5W	2%	27R
R 88	135	270	RESISTOR	THICK	FILM	0.5W	2%	27R
R 89	135	270	RESISTOR	THICK	FILM	0.5W	2%	27R
R 90	131	682	RESISTOR	CARBON	FILM	0.25W	5%	6K8
R 91	135	270	RESISTOR	THICK	FILM	0.5W	2%	27R

COMPONENT LIST 100-0021 PP39 PCB ISSUE 6

TR 9	295 550	TRANSISTOR 2N5550
TR 10	100-0016	3 TRANSISTOR HEATSINK ASSY
TR 11	290 056	TRANSISTOR MPS A56
TR 12	290 056	TRANSISTOR MPS A56
TR 15	295 550	TRANSISTOR 2N5550
TR 16	290 056	TRANSISTOR MPS A56
TR 17	290 056	TRANSISTOR MPS A56
TR 18	295 550	TRANSISTOR 2N5550
TR 19	295 550	TRANSISTOR 2N5550
TR 20	295 550	TRANSISTOR 2N5550
TR 21	295 550	TRANSISTOR 2N5550
TR 22	295 550	TRANSISTOR 2N5550
TR 23	295 550	TRANSISTOR 2N5550
TR 24	295 550	TRANSISTOR 2N5550
TR 25	100-0015	8 TRANSISTOR HEATSINK ASSY
RN 1	173 104	RESISTOR NETWORK 8RS SIL 100K
RN 2	173 104	RESISTOR NETWORK 8RS SIL 100K
RN 3	173 104	RESISTOR NETWORK 8RS SIL 100K
RN 4	173 104	RESISTOR NETWORK 8RS SIL 100K
RN 5	173 103	RESISTOR NETWORK SIL 8RS SIL 10K
RN 6	173 103	RESISTOR NETWORK SIL 8RS SIL 10K
RN 7	173 332	RESISTOR NETWORK 8RS SIL 3K3
VR 1	166 103	POT 3/8 SQ CERMET 10K
VR 2	166 103	POT 3/8 SQ CERMET 10K
VR 3	166 103	POT 3/8 SQ CERMET 10K
DN 1	10-0150	8 PIN DIODE PACK 1N4150
DN 2	10-0150	8 PIN DIODE PACK 1N4150
DN 3	10-0150	8 PIN DIODE PACK 1N4150
DN 4	10-0150	8 PIN DIODE PACK 1N4150
R 1	131 331	RESISTOR CARBON FILM 0.25W 5% 330R
R 2	131 102	RESISTOR CARBON FILM 0.25W 5% 1K0
R 3	131 221	RESISTOR CARBON FILM 0.25W 5% 220R
R 4	131 103	RESISTOR CARBON FILM 0.25W 5% 10K
R 5	131 681	RESISTOR CARBON FILM 0.25W 5% 680R
R 6	131 103	RESISTOR CARBON FILM 0.25W 5% 10K
R 7	131 333	RESISTOR CARBON FILM 0.25W 5% 33K
R 8	131 333	RESISTOR CARBON FILM 0.25W 5% 33K
R 9	131 333	RESISTOR CARBON FILM 0.25W 5% 33K
R 10	131 682	RESISTOR CARBON FILM 0.25W 5% 6K8
R 11	131 471	RESISTOR CARBON FILM 0.25W 5% 470R
R 12	131 471	RESISTOR CARBON FILM 0.25W 5% 470R
R 13	134 392	RESISTOR METAL FILM 0.25W 1% 3K9
R 14	134 241	RESISTOR METAL FILM 0.25W 1% 240R
R 15	131 272	RESISTOR CARBON FILM 0.25W 5% 2K7
R 16	131 471	RESISTOR CARBON FILM 0.25W 5% 470R
R 17	131 392	RESISTOR CARBON FILM 0.25W 5% 3K9
R 18	131 102	RESISTOR CARBON FILM 0.25W 5% 1K0
R 19	131 331	RESISTOR CARBON FILM 0.25W 5% 330R
R 20	131 102	RESISTOR CARBON FILM 0.25W 5% 1K0
R 21	131 102	RESISTOR CARBON FILM 0.25W 5% 1K0
R 22	131 681	RESISTOR CARBON FILM 0.25W 5% 680R
R 23	132 100	RESISTOR CARBON FILM 0.5W 5% 10R
R 24	133 047	RESISTOR CARBON FILM 1W 5% 4R7
R 25	131 682	RESISTOR CARBON FILM 0.25W 5% 6K8
R 26	131 151	RESISTOR CARBON FILM 0.25W 5% 150R
R 27	131 102	RESISTOR CARBON FILM 0.25W 5% 1K0
R 28	131 681	RESISTOR CARBON FILM 0.25W 5% 680R
R 29	131 102	RESISTOR CARBON FILM 0.25W 5% 1K0
R 30	131 102	RESISTOR CARBON FILM 0.25W 5% 1K0
R 31	131 332	RESISTOR CARBON FILM 0.25W 5% 3K3

COMPONENT LIST 100-0021 PP39 PCB ISSUE 6

REG 1	306 207	VOLTAGE REGULATOR 78L12
REG 2	306 241	VOLTAGE REGULATOR 79L12
REG 3	306 317	VOLTAGE REGULATOR LM317T
CON 1	462 038	MOLEX CONNECTOR 13 WAY 22-03-2131
CON 2	462 105	CONNECTOR DIN FEMALE 48 WAY
CON 3	463 025	CONNECTOR D-TYPE 25 WAY FEMALE RIGH
CON 4	462 100	CONNECTOR DIN FEMALE 64 WAY
CON 5	462 105	CONNECTOR DIN FEMALE 48 WAY
IC 1	320 255	I/O PORT 8255
IC 2	320 937	DISPLAY DRIVER 10937P-40
IC 3	20-0064	MODIFIED TDK1867 PSU
IC 4	313 109	IC DIGITAL 74LS SERIES 74LS109
IC 5	313 109	IC DIGITAL 74LS SERIES 74LS109
IC 6	320 551	UART SY6551A
IC 7	313 109	IC DIGITAL 74LS SERIES 74LS109
IC 8	308 007	CRYSTAL OSCILLATOR 16.000 MHZ
IC 9	315 489	IC BUFFER DS1489
IC 10	317 064	64K DRAM
IC 11	315 488	IC BUFFER DS1488
IC 12	317 064	64K DRAM
IC 13	317 116	RAM 6116
IC 14	100-0009	FPLA 82S153 PP39 IC14
IC 15	317 064	64K DRAM
IC 16	317 064	64K DRAM
IC 17	401 028	DIL SOCKET 28 WAY
IC 18	313 138	IC DIGITAL 74LS SERIES 74LS138
IC 19	317 064	64K DRAM
IC 20	313 138	IC DIGITAL 74LS SERIES 74LS138
IC 21	317 064	64K DRAM
IC 22	318 816	EEPROM 2816A
IC 23	100-0010	FPLA 82S153 PP39 IC23
IC 24	317 064	64K DRAM
IC 25	313 132	IC DIGITAL 74LS SERIES 74LS132
IC 26	317 064	64K DRAM
IC 27	320 080	PROCESSOR Z80
IC 28	172 101	RESISTOR NETWORK 8RS 100R
IC 29	313 157	IC DIGITAL 74LS SERIES 74LS157
IC 30	313 157	IC DIGITAL 74LS SERIES 74LS157
IC 31	310 006	IC DIGITAL 74 SERIES 7406
IC 32	320 255	I/O PORT 8255
IC 33	320 255	I/O PORT 8255
IC 34	320 255	I/O PORT 8255
IC 35	172 221	RESISTOR NETWORK 8RS 220R
IC 36	172 221	RESISTOR NETWORK 8RS 220R
IC 37	314 004	TRANSISTOR ARRAY ULN 2004
IC 38	172 221	RESISTOR NETWORK 8RS 220R
IC 39	314 004	TRANSISTOR ARRAY ULN 2004
IC 40	172 221	RESISTOR NETWORK 8RS 220R
IC 41	314 339	QUAD COMPARATOR LM339
IC 42	316 524	D TO A CONVERTOR AD 7524
IC 43	314 072	BIFET OP AMP TL072
IC 44	316 524	D TO A CONVERTOR AD 7524
IC 45	314 072	BIFET OP AMP TL072
IC 46	316 524	D TO A CONVERTOR AD 7524
IC 47	314 072	BIFET OP AMP TL072
TR 1	290 056	TRANSISTOR MPS A56
TR 4	295 550	TRANSISTOR 2N5550
TR 6	295 550	TRANSISTOR 2N5550
TR 7	290 056	TRANSISTOR MPS A56
TR 8	290 056	TRANSISTOR MPS A56

COMPONENT LIST 100-0031 PP39 PSU PCB ISSUE 3

REG 1	306 405	VOLTAGE REGULATOR LM340T5
REG 2	306 317	VOLTAGE REGULATOR LM317T
REG 3	306 215	VOLTAGE REGULATOR LM 320T15
REG 4	306 317	VOLTAGE REGULATOR LM317T
REG 5	306 317	VOLTAGE REGULATOR LM317T
CON 1	462 040	MOLEX CONNECTOR 11 WAY 10-16-1111
CON 2	462 040	MOLEX CONNECTOR 11 WAY 10-16-1111
VR 1	166 103	POT 3/8 SQ CERMET 10K
VR 2	166 103	POT 3/8 SQ CERMET 10K
R 1	131 562	RESISTOR CARBON FILM 0.25W 5% 5K6
R 2	134 241	RESISTOR METAL FILM 0.25W 1% 240R
R 3	134 682	RESISTOR METAL FILM 0.25W 1% 6K8
R 4	131 223	RESISTOR CARBON FILM 0.25W 5% 22K
R 5	134 241	RESISTOR METAL FILM 0.25W 1% 240R
R 6	131 183	RESISTOR CARBON FILM 0.25W 5% 18K
R 7	134 241	RESISTOR METAL FILM 0.25W 1% 240R
R 8	131 472	RESISTOR CARBON FILM 0.25W 5% 4K7
C 1	129 470	CAP. SERIES Y 0.0047uF 250Vac
C 2	129 470	CAP. SERIES Y 0.0047uF 250Vac
C 3	129 470	CAP. SERIES Y 0.0047uF 250Vac
C 4	110 040	CAP AL ELEC AXIAL 1000uF 63V
C 5	110 040	CAP AL ELEC AXIAL 1000uF 63V
C 6	110 039	CAP AL ELEC AXIAL 4700uF 16V
C 7	110 039	CAP AL ELEC AXIAL 4700uF 16V
C 8	110 042	CAP AL ELEC AXIAL 2200uF 25V
C 9	110 019	CAP AL ELEC AXIAL 1000uF 25V
C 10	123 100	CAP MULTILAYER CERAMIC 0.1uF 50V
C 11	123 100	CAP MULTILAYER CERAMIC 0.1uF 50V
C 12	123 100	CAP MULTILAYER CERAMIC 0.1uF 50V
C 13	123 100	CAP MULTILAYER CERAMIC 0.1uF 50V
C 14	123 100	CAP MULTILAYER CERAMIC 0.1uF 50V
C 15	120 102	CAP RESIN DIPPED TANT 10uF 35V
C 16	120 102	CAP RESIN DIPPED TANT 10uF 35V
M 1	260 004	RECTIFIER W02
M 2	260 004	RECTIFIER W02
M 3	260 004	RECTIFIER W02
M 4	260 005	RECTIFIER KBPC 102
M 5	100-0032	PP39 PSU PCB
M 6	434 004	PIEZO ALARM PKB8-4A0
M 7	400 060	SOLDER PIN D/S
M 8	400 060	SOLDER PIN D/S
M 9	400 060	SOLDER PIN D/S
M 10	400 060	SOLDER PIN D/S

5.3 Items Lists

5.3.1	PP39 Assembly	100-0000
5.3.2	PP39 Cover Moulding Assy	100-0003
5.3.3	PP39 Mainboard	100-0021
5.3.4	PP39 Base Assy	100-0002
5.3.5	PP39 Heatsink (87Rs)	100-0015
5.3.6	PP39 Heatsink (32RS)	100-0016
5.3.7	PP39 Cableform Assy	100-0014
5.3.8	PP39 PSU Board	100-0031

ITEMS LIST 100-0000 PP39 ASSY ISSUE 2

ITEM	PART NO.	DESCRIPTION	UNIT QTY
1	100-0003	PP39 COVER MOULDING ASSY	1
2	100-0021	PP39 MAIN BD ASSY	1
3	100-0002	PP39 BASE ASSY	1
4	432 100	SCREW PANHEAD SUPA STEEL M3 X 6	12
5	432 192	WASHER SHAKEPROOF M3	12

ITEMS LIST 100-0003 PP39 COVER M/DING ASSY ISSUE 1

ITEM	PART NO.	DESCRIPTION	UNIT QTY
1	100-0050	PP39 COVER MOULDING	1
2	100-0059	PP39 LABEL	1
3	100-0055	PP39 FILTER	1
4	100-0052	PP39 MEMBRANE PANEL	1

ITEMS LIST 100-0021 PP39 PCB ISSUE 6

ITEM	PART NO.	DESCRIPTION	UNIT QTY
1	131 102	RESISTOR CARBON FILM 0.25W 5% 1K0	18
2	131 103	RESISTOR CARBON FILM 0.25W 5% 10K	2
3	131 151	RESISTOR CARBON FILM 0.25W 5% 150R	3
4	131 221	RESISTOR CARBON FILM 0.25W 5% 220R	1
5	131 271	RESISTOR CARBON FILM 0.25W 5% 270R	1
6	131 272	RESISTOR CARBON FILM 0.25W 5% 2K7	13
7	131 331	RESISTOR CARBON FILM 0.25W 5% 330R	6
8	131 332	RESISTOR CARBON FILM 0.25W 5% 3K3	3
9	131 333	RESISTOR CARBON FILM 0.25W 5% 33K	4
10	131 392	RESISTOR CARBON FILM 0.25W 5% 3K9	3
11	131 471	RESISTOR CARBON FILM 0.25W 5% 470R	7
12	131 472	RESISTOR CARBON FILM 0.25W 5% 4K7	2
13	131 473	RESISTOR CARBON FILM 0.25W 5% 47K	3
14	131 561	RESISTOR CARBON FILM 0.25W 5% 560R	1
15	131 681	RESISTOR CARBON FILM 0.25W 5% 680R	7
16	131 682	RESISTOR CARBON FILM 0.25W 5% 6K8	7
17	131 822	RESISTOR CARBON FILM 0.25W 5% 8K2	2
18	132 100	RESISTOR CARBON FILM 0.5W 5% 10R	2
19	133 047	RESISTOR CARBON FILM 1W 5% 4R7	1
20	134 241	RESISTOR METAL FILM 0.25W 1% 240R	1
21	134 392	RESISTOR METAL FILM 0.25W 1% 3K9	1
22	134 560	RESISTOR METAL FILM 0.25W 1% 56R	2
23	135 180	RESISTOR THICK FILM 0.5W 2% 18R	2
24	135 270	RESISTOR THICK FILM 0.5W 2% 27R	7
25	284 148	DIODE 1N4148	38
26	288 107	DIODE ZENER 1.3W BZX 61 C15V	1
27	20-0064	MODIFIED TDK1867 PSU	1
28	100-0009	FPLA 82S153 PP39 IC14	1
29	100-0010	FPLA 82S153 PP39 IC23	1
30	172 101	RESISTOR NETWORK 8RS 100R	1
31	172 221	RESISTOR NETWORK 8RS 220R	4
32	308 007	CRYSTAL OSCILLATOR 16.000 MHZ	1
33	310 006	IC DIGITAL 74 SERIES 7406	1
34	313 109	IC DIGITAL 74LS SERIES 74LS109	3
35	313 132	IC DIGITAL 74LS SERIES 74LS132	1
36	313 138	IC DIGITAL 74LS SERIES 74LS138	2
37	313 157	IC DIGITAL 74LS SERIES 74LS157	2
38	314 004	TRANSISTOR ARRAY ULN 2004	2
39	314 072	BIFET OP AMP TL072	3
40	314 339	QUAD COMPARATOR LM339	1
41	315 488	IC BUFFER DS1488	1
42	315 489	IC BUFFER DS1489	1
43	316 524	D TO A CONVERTOR AD 7524	3
44	317 064	64K DRAM	8
45	317 116	RAM 6116	1
46	318 816	EEPROM 2816A	1
47	320 080	PROCESSOR Z80	1
48	320 255	I/O PORT 8255	4
49	320 551	UART SY6551A	1
50	320 937	DISPLAY DRIVER 10937P-40	1
51	401 028	DIL SOCKET 28 WAY	1
52	173 103	RESISTOR NETWORK SIL 8RS SIL 10K	2
53	173 104	RESISTOR NETWORK 8RS SIL 100K	4
54	173 332	RESISTOR NETWORK 8RS SIL 3K3	1
55	110 007	CAP AL ELEC RADIAL 1uF 63V	2
56	110 043	CAP AL ELEC AXIAL 47uF 10V	1

ITEMS LIST 100-0021 PP39 PCB ISSUE 6

ITEM	PART NO.	DESCRIPTION	UNIT QTY
57	110 044	CAP AL ELEC AXIAL 100uF 10V	1
58	120 104	CAP RESIN DIPPED TANT 1.5uF 35V	3
59	123 011	CAP CERAMIC PLATE 470pF 63V	4
60	123 100	CAP MULTILAYER CERAMIC 0.1uF 50V	23
61	123 474	CAP MULTILAYER CERAMIC 0.47uF 50V	3
62	124 102	CAP MULTILAYER CERAMIC 1000pF 50V	1
63	124 562	CAP MULTILAYER CERAMIC 5600pF 50V	1
64	100-0015	8 TRANSISTOR HEATSINK ASSY	1
65	100-0016	3 TRANSISTOR HEATSINK ASSY	1
66	290 056	TRANSISTOR MPS A56	7
67	295 550	TRANSISTOR 2N5550	11
68	306 207	VOLTAGE REGULATOR 78L12	1
69	306 241	VOLTAGE REGULATOR 79L12	1
70	306 317	VOLTAGE REGULATOR LM317T	1
71	166 103	POT 3/8 SQ CERMET 10K	3
72	308 003	CRYSTAL 1.8432 MHZ	1
73	462 038	MOLEX CONNECTOR 13 WAY 22-03-2131	1
74	462 100	CONNECTOR DIN FEMALE 64 WAY	1
75	462 105	CONNECTOR DIN FEMALE 48 WAY	2
76	463 025	CONNECTOR D-TYPE 25 WAY FEMALE RIGH	1
77	10-0150	8 PIN DIODE PACK 1N4150	4
78	100-0014	PP39 CABLE FORM ASSY	1
79	100-0022	PP39 PCB	1
80	309 165	DISPLAY FIP 16A5R	1
81	318 764	E PROM 2764	1
82	400 060	SOLDER PIN D/S	11

ITEMS LIST 100-0002 PP39 BASE ASSY ISSUE 2

ITEM	PART NO.	DESCRIPTION	UNIT QTY
1	100-0013	PP39 BASE SCREENED	1
2	100-0031	PP39 PSU PCB ASSY	1
3	100-0012	PP39 TRANSFORMER	1
4	100-0056	PP39 BLANKING PLATE	1
5	100-0058	PP39 SILPAD	1
6	100-0061	PP39 SRBP INSULATING PANEL	1
7	400 041	FUSE 20mm. QUICK BLOW 2A.	1
8	400 052	CABLE SLEEVE H30	7
9	462 025	MAINS CONNECTOR BL 2723	1
10	400 080	INSULATOR BASE IEC-TO-220-18	5
11	400 030	PLASTIC BUMP-ON FOOT	4
12	800 002	2 INCH D/SIDED TAPE LINEN	1
13	670 103	FAN ETRI 115V 99XM-01-82000	1
14	620 003	CABLE & PLUG for ETRI SERIES 99 FAN	1
15	432 100	SCREW PANHEAD SUPA STEEL M3 X 6	2
16	432 102	SCREW PANHEAD SUPA STEEL M3 X 10	5
17	432 307	SCREW PANHEAD SUPA STEEL M6 x 30	1
18	432 103	SCREW PANHEAD SUPA STEEL M3 X 12	3
19	432 391	WASHER FLAT STEEL M6	1
20	432 101	SCREW PANHEAD SUPA STEEL M3 X 8	4
21	432 192	WASHER SHAKEPROOF M3	17
22	432 392	WASHER SHAKEPROOF M6	2
23	433 091	WASHER PLASTIC M3	3
24	432 190	FULLNUT STEEL ZINC & CLEAR M3	8
25	432 390	FULLNUT STEEL M6	1

ITEMS LIST 100-0015 PP39 H/SINK ASSY (8TRS) ISSUE 2

ITEM	PART NO.	DESCRIPTION	UNIT QTY
1	100-0062	8 TRANSISTOR HEATSINK	1
2	100-0064	8 TRANSISTOR SILPAD PP39	2
3	290 251	TRANSISTOR MJE 251	8
4	432 103	SCREW PANHEAD SUPA STEEL M3 X 12	4
5	432 192	WASHER SHAKEPROOF M3	8
6	432 190	FULLNUT STEEL ZINC & CLEAR M3	4

ITEMS LIST 100-0016 PP39 H/SINK ASSY (3TRS) ISSUE 1

ITEM	PART NO.	DESCRIPTION	UNIT QTY
1	100-0063	3 TRANSISTOR HEATSINK	1
2	100-0065	3 TRANSISTOR SILPAD PP39	1
3	290 251	TRANSISTOR MJE 251	3
4	432 102	SCREW PANHEAD SUPA STEEL M3 X 10	3
5	432 192	WASHER SHAKEPROOF M3	6
6	432 190	FULLNUT STEEL ZINC & CLEAR M3	3

ITEMS LIST 100-0014 PP39 C/FORM MAIN BD/PSU ISSUE 2

ITEM	PART NO.	DESCRIPTION	UNIT QTY
1	462 041	MOLEX CONNECTOR 11 WAY 10-01-1114	1
4	462 015	MOLEX CONTACT 6838 TL	10
9	400 049	CABLE TIE TYB 23M	1
16	680 009	WIRE RED 24/0.2	1
17	680 010	WIRE GREY 24/0.2	1
18	680 011	WIRE BLACK 24/0.2	1
19	680 015	PVC EQUIP. WIRE 24/0.2mm GREEN	1
20	680 021	EQUIP WIRE 24/0.2mm BLUE	1
21	680 013	WIRE BROWN 16/0.2	1
22	680 014	WIRE ORANGE 16/0.2	1
23	680 022	PVC EQUIP WIRE 24/0.2 YELLOW	1

ITEMS LIST 100-0031 PP39 PSU PCB ISSUE 3

ITEM	PART NO.	DESCRIPTION	UNIT QTY
1	131 183	RESISTOR CARBON FILM 0.25W 5% 18K	1
2	131 223	RESISTOR CARBON FILM 0.25W 5% 22K	1
3	131 472	RESISTOR CARBON FILM 0.25W 5% 4K7	1
4	131 562	RESISTOR CARBON FILM 0.25W 5% 5K6	1
5	134 241	RESISTOR METAL FILM 0.25W 1% 240R	3
6	134 682	RESISTOR METAL FILM 0.25W 1% 6K8	1
7	110 019	CAP ALUM ELECTROLYTIC 1000uF 25V	1
8	110 039	CAP AL ELEC AXIAL 4700uF 16V	2
9	110 040	CAP AL ELEC AXIAL 1000uF 63V	2
10	110 042	CAP AL ELEC AXIAL 2200uF 25V	1
11	120 102	CAP RESIN DIPPED TANT 10uF 35V	2
12	123 100	CAP MULTILAYER CERAMIC 0.1uF 50V	5
13	129 470	CAP. SERIES Y 0.0047uF 250Vac	3
14	306 215	VOLTAGE REGULATOR LM 320T15	1
15	306 317	VOLTAGE REGULATOR LM317T	3
16	306 405	VOLTAGE REGULATOR LM340T5	1
17	166 103	POT CERMET 3/8 in SQ 10K	2
18	462 040	MOLEX CONNECTOR 11 WAY 10-16-1111	2
19	100-0032	PP39 PSU PCB	1
20	260 004	RECTIFIER W02	3
21	260 005	RECTIFIER KBPC 102	1
22	400 060	SOLDER PIN D/S	4
23	434 004	PIEZO ALARM PKB8-4A0	1

6.0 Component Location

6.1	Mainboard	100-0021
6.2	PSU Board	100-0031

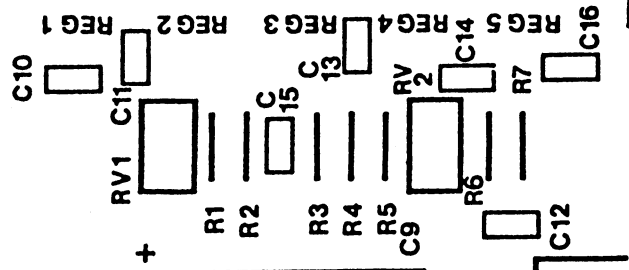
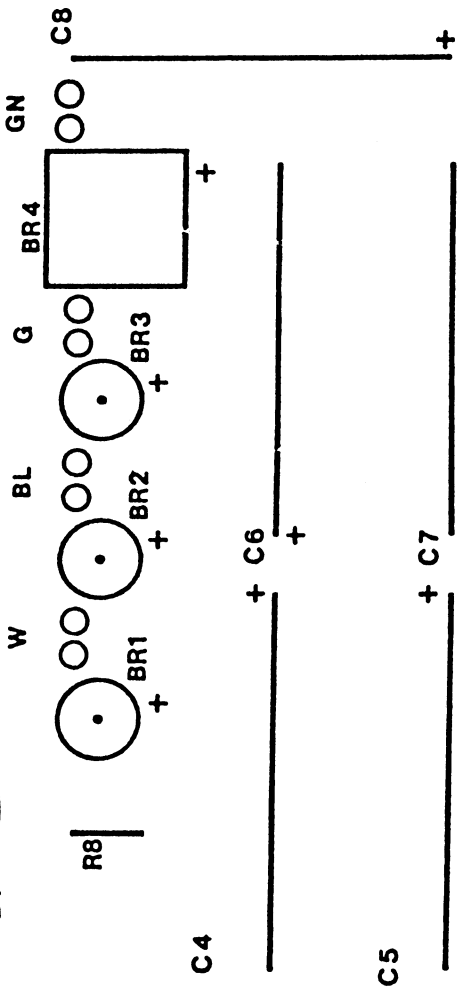
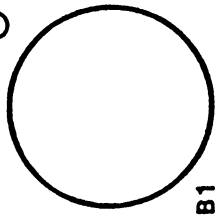
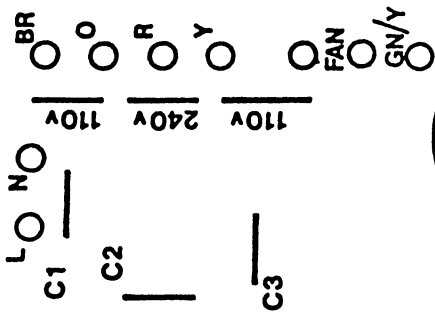

7.0 Circuit Diagrams

7.1	PP39 Mainboard	100-0021
7.2	PP39 PSU Board	100-0031

8.1 39M100 Module

- 8.1.1 Component List
- 8.1.2 Items List
- 8.1.3 Circuit Diagram

COMPONENT LIST 105-0001 39M100 PCB ASSY ISSUE 3

CON 1	401 128	TEXTTOOL SOCKET 28 WAY
CON 2	401 128	TEXTTOOL SOCKET 28 WAY
CON 3	462 104	CONNECTOR DIN MALE 48 WAY
CON 4	462 104	CONNECTOR DIN MALE 48 WAY
LED 1	309 209	LED TIL 209
LED 2	309 209	LED TIL 209
LED 3	309 209	LED TIL 209
LED 4	309 209	LED TIL 209
IC 1	401 428	28 WAY DIL CARRIER A28-KT-103d/HZ
IC 2	323 373	CMOS DIGITAL IC 74HC373
IC 3	323 373	CMOS DIGITAL IC 74HC373
IC 4	313 000	IC DIGITAL 74LS SERIES 74LS00
IC 5	313 122	IC DIGITAL 74LS SERIES 74LS122
IC 6	172 221	RESISTOR NETWORK 8RS 220R
IC 7	172 221	RESISTOR NETWORK 8RS 220R
VR 1	167 104	POT CITEC MPWT 100K
R 1	131 472	RESISTOR CARBON FILM 0.25W 5% 4K7
R 2	131 224	RESISTOR CARBON FILM 0.25W 5% 220K
R 3	131 221	RESISTOR CARBON FILM 0.25W 5% 220R
R 4	131 221	RESISTOR CARBON FILM 0.25W 5% 220R
R 5	131 271	RESISTOR CARBON FILM 0.25W 5% 270R
R 6	131 271	RESISTOR CARBON FILM 0.25W 5% 270R
R 7	131 271	RESISTOR CARBON FILM 0.25W 5% 270R
R 8	131 271	RESISTOR CARBON FILM 0.25W 5% 270R
D 1	284 148	DIODE 1N4148
D 2	284 148	DIODE 1N4148
D 3	284 148	DIODE 1N4148
D 4	284 148	DIODE 1N4148
D 5	284 148	DIODE 1N4148
D 6	284 148	DIODE 1N4148
D 7	284 148	DIODE 1N4148
C 1	123 100	CAP MULTILAYER CERAMIC 0.1uF 50V
C 2	123 012	CAP CERAMIC PLATE 4.7pF 63V
C 8	124 103	CAP MULTILAYER CERAMIC 10000pF 50V
C 9	124 103	CAP MULTILAYER CERAMIC 10000pF 50V
C 10	124 103	CAP MULTILAYER CERAMIC 10000pF 50V
C 11	124 103	CAP MULTILAYER CERAMIC 10000pF 50V
C 12	124 103	CAP MULTILAYER CERAMIC 10000pF 50V
C 13	124 103	CAP MULTILAYER CERAMIC 10000pF 50V
C 14	124 103	CAP MULTILAYER CERAMIC 10000pF 50V
M 1	318 7256	256K E-PROM
M 2	105-0002	PP39 39M100 PCB

ITEMS LIST 105-0008 39M100 MODULE ASSY ISSUE 2

ITEM	PART NO.	DESCRIPTION	UNIT QTY
1	105-0001	39M100 PCB ASSY	1
2	105-0009	PP39 39M100 TEXTTOOL COVER SCREENED	1
3	100-0051	PP39 TEXTTOOL COVER MOULDING	1
12	432 103	SCREW PANHEAD SUPA STEEL M3 X 12	5
20	432 192	WASHER SHAKEPROOF M3	5

ITEMS LIST 105-0001 39M100 PCB ASSY ISSUE 3

ITEM	PART NO.	DESCRIPTION	UNIT QTY
1	131 221	RESISTOR CARBON FILM 0.25W 5% 220R	2
2	131 224	RESISTOR CARBON FILM 0.25W 5% 220K	1
3	131 271	RESISTOR CARBON FILM 0.25W 5% 270R	4
4	131 472	RESISTOR CARBON FILM 0.25W 5% 4K7	1
5	284 148	DIODE 1N4148	7
6	172 221	RESISTOR NETWORK 8RS 220R	2
7	313 000	IC DIGITAL 74LS SERIES 74LS00	1
8	313 122	IC DIGITAL 74LS SERIES 74LS122	1
9	323 373	CMOS DIGITAL IC 74HC373	2
10	401 428	28 WAY DIL CARRIER A28-KT-103d/HZ	1
11	123 012	CAP CERAMIC PLATE 4.7pF 63V	1
12	123 100	CAP MULTILAYER CERAMIC 0.1uF 50V	1
13	124 103	CAP MULTILAYER CERAMIC 10000pF 50V	7
14	167 104	POT CITEC MPWT 100K	1
15	401 128	TEXTTOOL SOCKET 28 WAY	2
16	462 104	CONNECTOR DIN MALE 48 WAY	2
17	309 209	LED TIL 209	4
18	105-0002	PP39 39M100 PCB	1
19	318 7256	256K E-PROM	1

8.2 39M200 Module

- 8.2.1 Component List
- 8.2.2 Items Lists
- 8.2.3 Circuit Diagram

COMPONENT LIST 105-0211 39M200 PCB ASSY ISSUE 1

CON 1	462 104	CONNECTOR DIN MALE 48 WAY
CON 2	462 104	CONNECTOR DIN MALE 48 WAY
LED 1	309 209	LED TIL 209
LED 2	309 209	LED TIL 209
LED 3	309 209	LED TIL 209
LED 4	309 209	LED TIL 209
IC 1	310 136	IC DIGITAL 74 SERIES 74136
IC 2	313 109	IC DIGITAL 74LS SERIES 74LS109
IC 3	313 373	IC DIGITAL 74LS SERIES 74LS373
IC 4	313 373	IC DIGITAL 74LS SERIES 74LS373
IC 5	321 040	DIGITAL CMOS CD4040B
IC 6	105-0208	FPLA 82S153 39M200 IC6
IC 7	105-0207	FPLA 82S153 39M200 IC7
IC 8	401 140	TEXTTOOL SOCKET 40 WAY
IC 9	401 140	TEXTTOOL SOCKET 40 WAY
IC 10	401 140	TEXTTOOL SOCKET 40 WAY
IC 11	401 128	TEXTTOOL SOCKET 28 WAY
IC 12	401 024	DIL SOCKET 24 WAY
IC 13	317 116	RAM 6116
IC 14	317 116	RAM 6116
IC 15	401 028	DIL SOCKET 28 WAY
TR 1	290 056	TRANSISTOR MPS A56
DN 1	10-0150	8 PIN DIODE PACK 1N4150
R 1	131 271	RESISTOR CARBON FILM 0.25W 5% 270R
R 2	131 271	RESISTOR CARBON FILM 0.25W 5% 270R
R 3	131 271	RESISTOR CARBON FILM 0.25W 5% 270R
R 4	131 271	RESISTOR CARBON FILM 0.25W 5% 270R
R 5	131 471	RESISTOR CARBON FILM 0.25W 5% 470R
R 6	131 471	RESISTOR CARBON FILM 0.25W 5% 470R
R 7	131 471	RESISTOR CARBON FILM 0.25W 5% 470R
R 8	131 102	RESISTOR CARBON FILM 0.25W 5% 1K0
D 1	284 148	DIODE 1N4148
D 2	284 148	DIODE 1N4148
D 3	284 148	DIODE 1N4148
D 4	284 148	DIODE 1N4148
D 5	284 148	DIODE 1N4148
D 6	284 148	DIODE 1N4148
D 7	284 148	DIODE 1N4148
C 1	124 103	CAP MULTILAYER CERAMIC 10000pF 50V
C 2	124 103	CAP MULTILAYER CERAMIC 10000pF 50V
C 3	124 103	CAP MULTILAYER CERAMIC 10000pF 50V
C 4	124 103	CAP MULTILAYER CERAMIC 10000pF 50V
C 5	124 103	CAP MULTILAYER CERAMIC 10000pF 50V
C 6	124 103	CAP MULTILAYER CERAMIC 10000pF 50V
C 7	124 103	CAP MULTILAYER CERAMIC 10000pF 50V
C 8	123 100	CAP MULTILAYER CERAMIC 0.1uF 50V
C 9	123 100	CAP MULTILAYER CERAMIC 0.1uF 50V
C 10	123 100	CAP MULTILAYER CERAMIC 0.1uF 50V
C 11	123 100	CAP MULTILAYER CERAMIC 0.1uF 50V
M 1	105-0212	PP39 39M200 PCB
M 2	340 004	RELAY RS 349 399 FORM C
M 12	318 716	EPROM 2716
M 15	318 7256	256K E-PROM

ITEMS LIST 105-0211 39M200 PCB ASSY ISSUE 1

ITEM	PART NO.	DESCRIPTION	UNIT QTY
1	131 102	RESISTOR CARBON FILM 0.25W 5% 1K0	1
2	131 271	RESISTOR CARBON FILM 0.25W 5% 270R	4
3	131 471	RESISTOR CARBON FILM 0.25W 5% 470R	3
4	284 148	DIODE 1N4148	7
5	105-0207	FPLA 82S153 39M200 IC7	1
6	105-0208	FPLA 82S153 39M200 IC6	1
7	310 136	IC DIGITAL 74 SERIES 74136	1
8	313 109	IC DIGITAL 74LS SERIES 74LS109	1
9	313 373	IC DIGITAL 74LS SERIES 74LS373	2
10	317 116	RAM 6116	2
11	321 040	DIGITAL CMOS CD4040B	1
12	401 024	DIL SOCKET 24 WAY	1
13	401 028	DIL SOCKET 28 WAY	1
14	401 128	TEXTTOOL SOCKET 28 WAY	1
15	401 140	TEXTTOOL SOCKET 40 WAY	3
16	123 100	CAP MULTILAYER CERAMIC 0.1uF 50V	4
17	124 103	CAP MULTILAYER CERAMIC 10000pF 50V	7
18	290 056	TRANSISTOR MPS A56	1
19	462 104	CONNECTOR DIN MALE 48 WAY	2
20	309 209	LED TIL 209	4
21	10-0150	8 PIN DIODE PACK 1N4150	1
22	105-0212	PP39 39M200 PCB	1
23	318 716	EPROM 2716	1
24	318 7256	256K E-PROM	1
25	340 004	RELAY RS 349 399 FORM C	1

